

# Welcome



Lightcloud®

0-10V Dimmer

XDIM/D10/LCB

WE'RE HERE TO HELP:

**1(844) LIGHTCLOUD**

1(844) 544-4825

# Hello

The Lightcloud Blue 0-10V Dimmer can be used to control the wired standard 0-10V lighting or wirelessly control the Lightcloud Blue-enabled lighting, no Gateway or Hub required. Easily use the up/down paddle to adjust the dim level or turn lights on/off. Indicator lights illuminate to reflect current brightness levels and online status.

## Product Features & Specifications

- Voltage: 120-277V
- Color: Matte White
- Dimming Protocol: 0-10V
- Max Load (Dimming Capacity):
  - 120VAC 50/60Hz 10A
  - 277VAC 50/60Hz 5A
- Warranty:
  - 3-year, limited warranty
- Compatible with a broad range of high-efficiency loads
- Power monitoring
- High/Low end adjustment

## Safety Information

- To avoid risk of fire and electrical shock, products shall be installed in accordance with electrical code and regulations.
- Cut off the power at the circuit breaker or fuse before installation.
- If you're not clear about any content of the instructions, please consult a licensed electrician.
- To avoid the risk of overheating and possible damage to the equipment, do not use the product to control a receptacle, motor-operated appliance or a transformer-supplied appliance.
- This product can only be used with a matching 0-10V dimming power supply or fixture.
- When a dimmer is connected to multiple 0-10V dimmers or lamps, don't mix different models of 0-10V dimmers or lamps. Using the same model of 0-10V dimmers or lamps will improve the dimming performance of the system.

WE'RE HERE TO HELP:

**1 (844) LIGHTCLOUD**

1 (844) 544-4825

[support@lightcloud.com](mailto:support@lightcloud.com)

# Parts Included and Tools Needed

## ① Parts Included

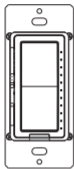

Dimmer (1 pcs)



Base Plate  
(1 pcs)

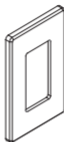

Face Plate  
(1 pcs)



Jumper Wire  
(1 pcs)



Mounting  
Screws (2 pcs)



5PIN Wiring  
Terminal (2 pcs)



2PIN Wiring  
Terminal (5 pcs)



Connection Wire (7pcs)

## ② Tools Needed to Install the Dimmer

- 5mm Philips Screwdriver
- Test Pencil
- Electrical Tape
- Pliers
- Electrician Knife
- Ruler

# Basic Operation

## ① Replaceable Control Component

- Control Component can detach from Power/Communication Component.

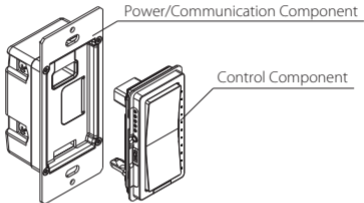

## Basic Operation *(cont'd)*

### ② Functional Parts

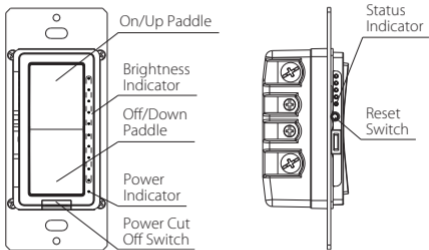

- Short Press: Within 0.5 seconds
- Long Press: Over 0.5 seconds
- Double Press: Within 1 second

#### 2a Power Indicator

- White indicator light will remain on for 3 seconds. The timeout and brightness of the indicator lights can be adjusted in the Lightcloud Blue app.

## Basic Operation *(cont'd)*

### 2b On/Up Paddle

- Turn light on: When the light is off, short press the On/Up Paddle once
- Continuously increase brightness: When the light is on, short press the On/Up Paddle, the brightness increases until the brightness reaches 100%
- Gradually increase brightness: When the light is on, press and hold the On/Up Paddle, the brightness will gradually increase until the brightness reaches the minimum level or until the On/Up is released
- Quickly adjust brightness: When the light is on or off, press the On/Up Paddle for 2 consecutive times

### 2c Off/Down Paddle

- Turn light off: When the light is on, short press the Off/Down Paddle once
- Quickly adjust to the lowest dim level: When the light is on or off, press the Off/Down Paddle 2 times
- Gradually decrease brightness: When the light is on, press and hold the Off/Down Paddle, the brightness will gradually decrease until the brightness reaches the minimum level or until the Off/Down Paddle is released

## Basic Operation *(cont'd)*

### 2d Reset Switch

- Restoring factory settings: Press and hold the reset switch until the status indicator light blinks red. The dimmer is now reset and ready to be paired. *(The dimmer is waiting to be added to the Lightcloud Blue network.)*

*Note: When pairing to the Lightcloud Blue APP, Bluetooth must be enabled on the mobile device.*

### 2e Status Indicator Light

- Flash red *(1s on/ 1s off)*: Device is not provisioned
- Steady green: Device is provisioned

### 2f Power Cut Off Switch

- Push in to connect to line voltage
- Pull out to disconnect light voltage



## Basic Operation *(cont'd)*

### 2g Brightness Indicator

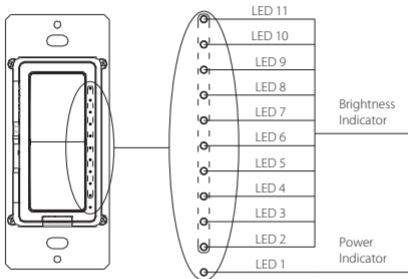

## Basic Operation *(cont'd)*

No.	Brightness Level	Brightness Indicator
1	Brightness Level 10	LED 2~LED 11
2	Brightness Level 9	LED 2~LED 10
3	Brightness Level 8	LED 2~LED 9
4	Brightness Level 7	LED 2~LED 8
5	Brightness Level 6	LED 2~LED 7
6	Brightness Level 5	LED 2~LED 6
7	Brightness Level 4	LED 2~LED 5
8	Brightness Level 3	LED 2~LED 4
9	Brightness Level 2	LED 2~LED 3
10	Brightness Level 1	LED 2

*Note: Brightness Indicator lights will stay illuminated while circuit is powered on.*

# Installing your Lightcloud Blue Device

## 1 Turn off Power

- Place the wall switch in the off position.
- Turn off the main power at the breaker panel or remove the fuse from the fuse box.



## 2 Remove Existing Switch

- Remove existing wall panel and switch mounting screws.
- Carefully pull switch from wall box, identify and remove the wires attached to the switch, then remove the switch.
- Do not remove the wires from the wall at this time.  
*(for new installations where an existing switch does not exist, skip this step.)*

## 3 Find a Suitable Location

- Lightcloud Blue devices should be positioned within 60 ft. of each other.
- Building materials such as brick, concrete and steel construction may require additional Lightcloud Blue devices to extend around an obstruction.

# Installing your Lightcloud Blue Device (cont'd)

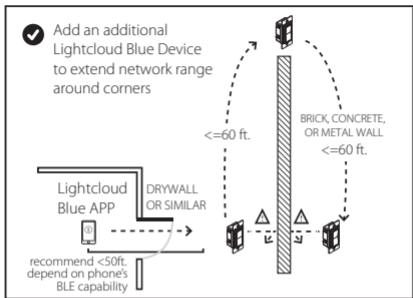

## 4 Identify the Type of Circuit

*Note If the wiring layout in the wall box does not resemble any of these configurations, consult an electrician.*

### IMPORTANT NOTE:

For a Single-Pole application, note that one of the screw terminals from the old switch being removed usually is a different color (*Black*) or labeled Common. Tag the wire with electrician tape and identify as the Common (*hot wire or load*) in both the dimmer wall box and Single-Pole wall box.

# Installing your Lightcloud Blue Device

(cont'd)

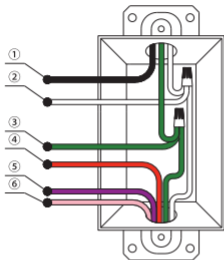

Single-Pole

- ① Hot
- ② Neutral
- ③ Ground
- ④ Load
- ⑤ 0-10V +
- ⑥ 0-10V -

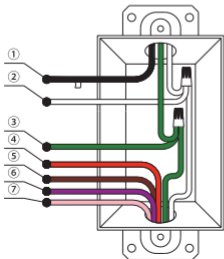

3-Way

- ① Hot or Load
- ② Neutral
- ③ Ground
- ④ Traveler 1
- ⑤ Traveler 2
- ⑥ 0-10V +
- ⑦ 0-10V -

## Installing your Lightcloud Blue Device (cont'd)

### 5 Typical Wiring

#### 5a Single-Pole

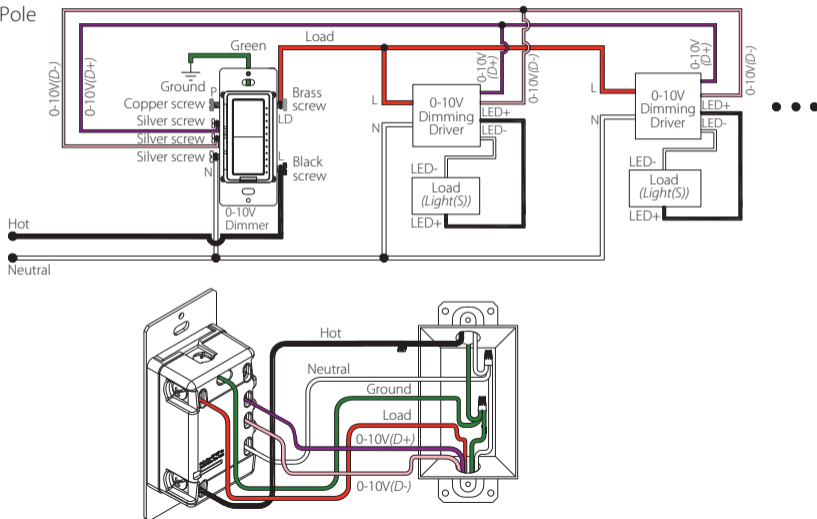

## Installing your Lightcloud Blue Device (cont'd)

### 5b 3-Way (3-way switch for retrofit installation)

Wiring Scheme 1

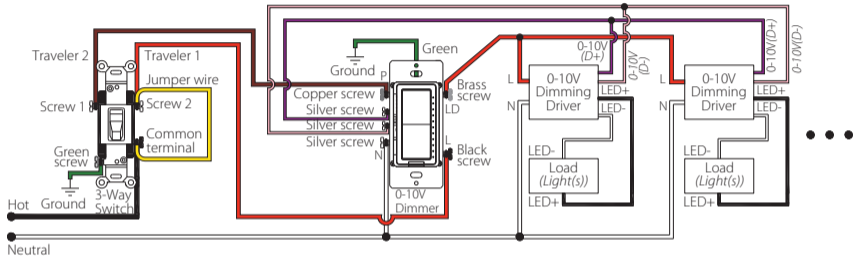

Wiring Scheme 2

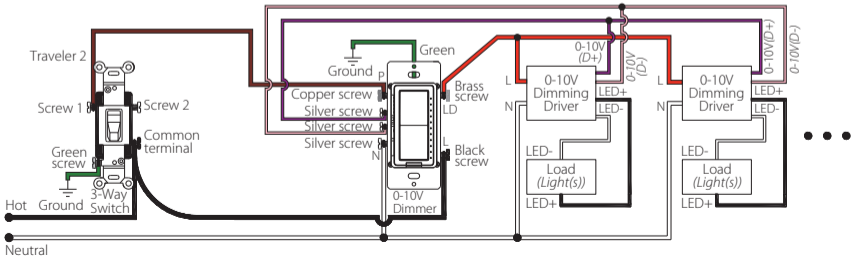

# Installing your Lightcloud Blue Device

*(cont'd)*

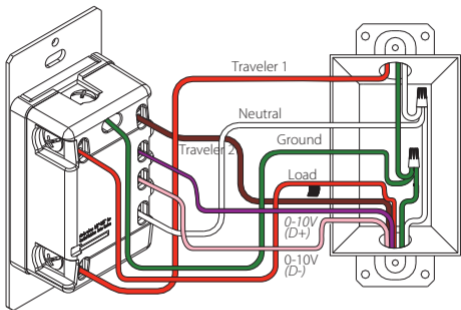



## Installing your Lightcloud Blue Device (cont'd)

### 5c 3-Way (toggle switch for new construction installation)

Wiring Scheme 3

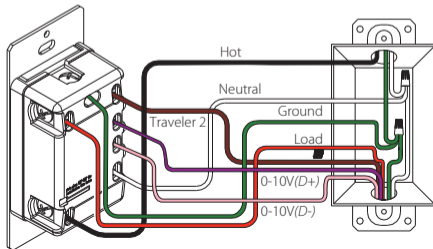
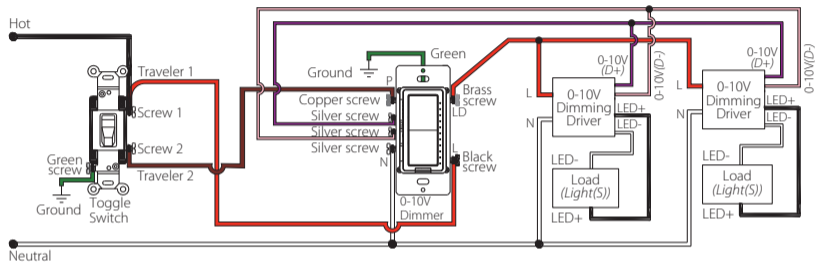

# Installing your Lightcloud Blue Device *(cont'd)*

## ⑥ Install and Fix the Dimmer

- Carefully position all wires inside the wall box, leaving enough room to insert the dimmer housing. Secure the dimmer with the mounting screws provided.

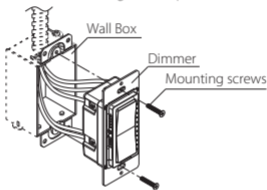

## ⑦ Install the Wall Plate

### 7a Separate Plate

- Place the base plate over the installed dimmer and secure it using provided screws.

# Installing your Lightcloud Blue Device

(cont'd)

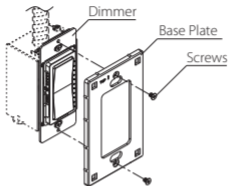

- Connect the face plate to the installed base plate and gently push it until it clicks into place.

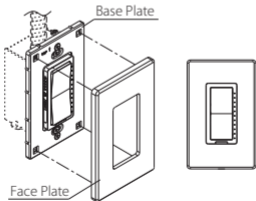

# Controlling your Lightcloud Blue Device

- 1 Confirm your device is powered on.
- 2 Download the Lightcloud Blue app from the Apple® App Store or Google® Play store.



- 3 Launch the app and create an account.



- 4 Tap the "add device" icon in the app to start connecting devices.



- 5 Follow the remaining steps in the app to create areas, groups and scenes which organize and control your devices.
- 6 Adjust the min-trim level to get the lowest dim level in the device setting to get best performance (Default 1%).
- 7 You're all set!

# Setting Device to Pairing Mode

To restore your Lightcloud Blue Dimmer to factory settings, use the following methods.

## Method 1: Delete from App

Open the app and access the device settings for the paired device. Be sure that the dimmer is online and select "Delete".

## Method 2: Reset Switch

Press and hold the reset switch until the status indicator blinks red (*the dimmer is waiting for the distribution network*).

*Note: When pairing to the Lightcloud Blue app, Bluetooth must be enabled on the mobile device.*

# Functionality

## Configuration

All configuration of Lightcloud Blue products may be performed using the Lightcloud Blue app.

## Emergency default

If communication is lost, the Lightcloud Blue lamps may fall back to a specific state, such as turning the Lightcloud Blue lamps on.

## *RF EXPOSURE STATEMENT*

*This equipment complies with the FCC RF radiation exposure limits set forth for an uncontrolled environment. This equipment should be installed and operated with a minimum distance of 20cm between the radiator and any part of your body.*

*FCC Information:*

*This device complies with Part 15 of the FCC Rules. Operation is subject to the following two conditions: (1) This device may not cause harmful interference, and (2) This device must accept any interference received, including interference that may cause undesired operation. These limits are designed to provide reasonable protection against harmful interference in a residential installation. This equipment generates, uses and can radiate radio frequency energy and, if not installed and used in accordance with the instructions, may cause harmful interference to radio communications. However, there is no guarantee that interference will not occur in a particular installation. If this equipment does cause harmful interference to radio or television reception, which can be determined by turning the equipment off and on, the user is encouraged to try to correct the interference by one or more of the following measures:*

- Reorient or relocate the receiving antenna.*
- Increase the separation between the equipment and receiver.*
- Connect the equipment into an outlet on a circuit different from that to which the receiver is connected.*
- Consult the dealer or an experienced radio/TV technician for help.*

*FCC CAUTION:*

*Any changes or modifications to this unit not expressly approved by the manufacture could void the user's authority to operate the equipment.*



Lightcloud®

Lightcloud Blue is a Bluetooth mesh wireless lighting control system that allows you to control RAB's various compatible devices. Each device in a system can communicate with any other device, eliminating the need for a Gateway or Hub and maximizing the control system's reach.

Learn more at [www.lightcloud.com](http://www.lightcloud.com)

1(844) LIGHTCLOUD

1(844) 544-4825

**RAB**®

©2023 RAB LIGHTING Inc.

Made in China

Pat. [rablighting.com/ip](http://rablighting.com/ip)