

Color: Black

Weight: 0.1 lbs

Project:	Type:
Prepared By:	Date:

Technical Specifications

Performance

Product Type:

Wafer Trim

Description:

Black smooth round color trim for compatible 6" wafer downlights.

Installation

Mounting:

Snap on

Construction

Size:

6"

Shape:

Round

Finish:

Black

Housing Material:

Metal

Trim Style:

Smooth

Compliance

Listings:

None

Environment:

Suitable for use in dry and damp environments. Not suitable for applications with direct sunlight.

T20 Compliant:

Not applicable

California Title 24 JA8 Compliant:

Not applicable

California Energy Commission (CEC) Status:

Lawful for Sales in California

Other

Compatible Products:

See Downlight Accessory Compatibility List for a complete listing of compatible products.

Buy American Act Compliance:

RAB values USA manufacturing! Upon request, RAB may be able to manufacture this product to be compliant with the Buy American Act (BAA). Please contact customer service to request a quote for the product to be made BAA compliant.

Dimensions

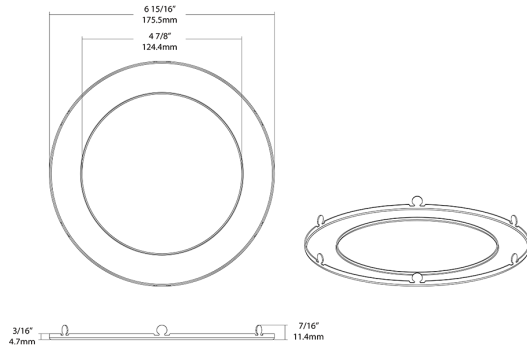

Features

Trims for Edge-Lit Wafer