



Partial LED Vaporproof fixture requires RAB Globe and Guard. Can be used with color globes.

Color: Natural

Weight: 5.1 lbs

<b>Project:</b>	<b>Type:</b>
<b>Prepared By:</b>	<b>Date:</b>

Driver Info		LED Info	
Type	Constant Current	Watts	26W
120V	0.25A	Color Temp	4000K (Neutral)
208V	0.14A	Color Accuracy	82 CRI
240V	0.13A	L70 Lifespan	100,000 Hours
277V	0.11A	Lumens	1,735 lm
Input Watts	26.5W	Efficacy	65.5 lm/W

## Technical Specifications

### Performance

#### Lifespan:

100,000-Hour LED lifespan based on IES LM-80 results and TM-21 calculations

### Construction

#### Specification:

These specifications are for fixture with Frosted Glass Globe and Die Cast Guard combination. Consult warehouse for different fixture combinations.

#### Globes and Guards:

Vaporproof LEDs are compatible with RAB Globes and Guards

#### Cold Weather Starting:

The minimum starting temperature is -40°C (-40°F)

#### Ambient Temperature:

Suitable for use in up to 40°C (104°F)

#### Housing:

All die-cast aluminum construction

#### Gaskets:

High-temperature silicone

#### Finish:

Natural shot blasted aluminum

#### Mounting:

(3) 3/4" NPS conduit entry points

#### Green Technology:

Mercury and UV free. RoHS-compliant components.

### Compliance

#### UL Listed:

Suitable for Wet locations only with outer globe and as a Downlight

### LED Characteristics

#### LED:

Multi-chip 26W high-output, long-life LED

#### Color Temperature:

4000K

#### Color Consistency:

3-step MacAdam Ellipse binning to achieve consistent fixture-to-fixture color

#### Color Stability:

LED color temperature is warrantied to shift no more than 200K in color temperature over a 5-year period

#### Color Uniformity:

RAB's range of Correlated Color Temperature follows the guidelines of the American National Standard for Specifications for the Chromaticity of Solid State Lighting (SSL) Products, ANSI C38.377-2011.

### Other

#### Patents:

The design of the LVAPOR is protected by the following patents US D653,795; D651738 CN ZL201130028359.7; ZL201130028360.X, TW pat. pending MX 35699; pat. pending CA.

#### Warranty:

RAB warrants that our LED products will be free from defects in materials and workmanship for a period of five (5) years from the date of delivery to the end user, including coverage of light output, color stability, driver performance and fixture finish. RAB's warranty is subject to all terms and conditions found at [rablighting.com/warranty](http://rablighting.com/warranty).

#### Buy American Act Compliance:

RAB values USA manufacturing! Upon request, RAB may be able to manufacture this product to be compliant with the Buy American Act (BAA). Please contact customer service to request a quote for the product to be made BAA compliant.

## Technical Specifications (continued)

### Optical

#### BUG Rating:

B0 U3 G1

### Electrical

#### Driver:

Constant Current, 100V-277V, 50/60 Hz, 0.48 Amp,  
THD is less than or equal to 20% Power Factor 97.9%.

## Dimensions

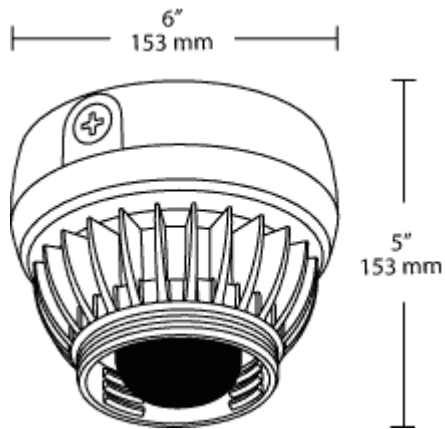

## Features

- High performance LED light engine
- 100,000-hour life based on LM-80 results and TM-21 calculations
- Die Cast Aluminum Housing
- Classic design with state of the art LED technology