

VXBRLED with Globe & Guard INSTRUCTIONS

RAB
LIGHTING

Thank you for buying RAB lighting fixtures. Our goal is to design the best quality products to get the job done right. We'd like to hear your comments. Call the Marketing Department at 888-RAB-1000 or email: marketing@rabweb.com



IMPORTANT

READ CAREFULLY BEFORE INSTALLING FIXTURE. RETAIN THESE INSTRUCTIONS FOR FUTURE REFERENCE.

RAB fixtures must be wired in accordance with the National Electrical Code and all applicable local codes. Proper grounding is required for safety. THIS PRODUCT MUST BE INSTALLED IN ACCORDANCE WITH THE APPLICABLE INSTALLATION CODE BY A PERSON FAMILIAR WITH THE CONSTRUCTION AND OPERATION OF THE PRODUCT AND THE HAZARDS INVOLVED.

WARNING: Make certain power is OFF before installing or maintaining fixture. No user serviceable parts inside.

WALL MOUNT

Fixture must be wall mounted. Use recessed or surface mount junction box (not supplied) or use the **Housing** as the junction box. **Fixture cannot be mounted upside down in wet locations!**

1. Loosen **Housing Screws** and open **Housing**.
2. Prepare back of **Housing** to use by knocking out necessary mounting holes.
3. Seal all gaps between wall and fixture with weatherproof silicone sealant.
4. Fixture may be wired through back conduit entrance or side conduit entrance for surface mounting.
5. Connect wires as shown in wiring section.
6. Close **Housing**. Tighten screws and check **Housing Gasket** seal.
7. Seal all holes, plugs and conduit entrances with weatherproof silicone sealant.

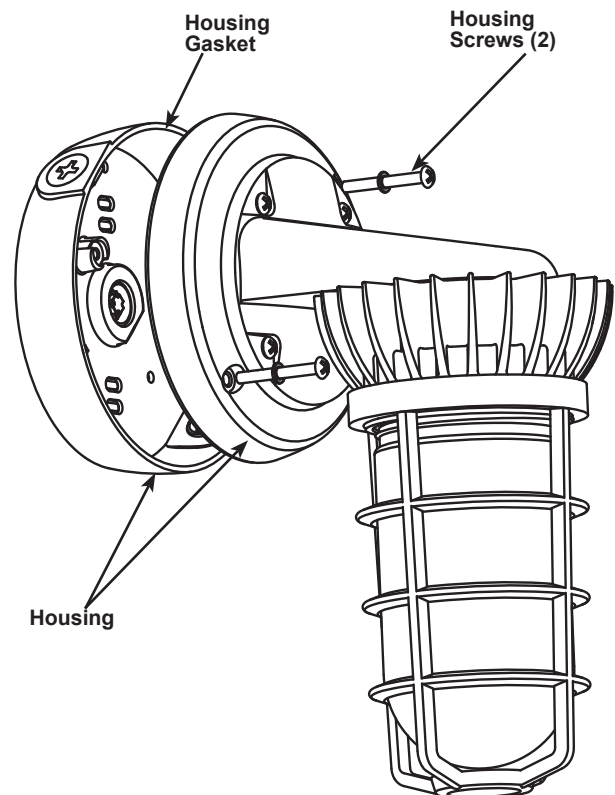

VXBRLED with Globe & Guard INSTRUCTIONS



Thank you for buying RAB lighting fixtures. Our goal is to design the best quality products to get the job done right. We'd like to hear your comments. Call the Marketing Department at 888-RAB-1000 or email: marketing@rabweb.com

WIRING

Universal voltage driver permits operation at 120V thru 277V, 50 or 60 Hz.

1. Connect the black fixture lead to the (+) LINE supply lead.
2. Connect the white fixture lead to the (-) COMMON supply lead.
3. Connect the GROUND wire from fixture to supply ground.

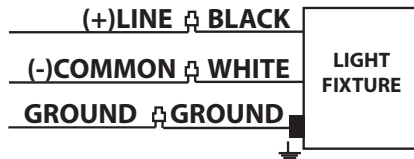

PHOTOCELL INSTALLATION

Photocell may be wired in the field. Apply weatherproof silicone sealant to all plugs and unused conduit entries.

1. Install photocell and wire as per diagram.
2. Use photocell rated for your supply voltage.

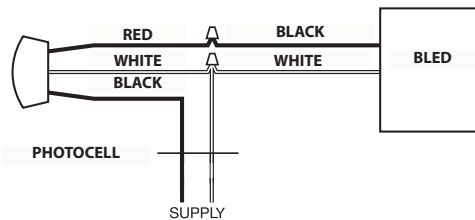

TROUBLESHOOTING

1. Check that the line voltage at fixture is correct.
2. Is there voltage at the lamp fixture wires? If there is no voltage, check all connections.
3. Is the fixture is grounded properly?

CLEANING & MAINTENANCE

CAUTION: Be sure fixture temperature is cool enough to touch. Do not clean or maintain while fixture is energized.

1. Clean glass lens & fixture with non-abrasive glass cleaning solution.
2. Do not open fixture to clean the LED. Do not touch the LED.

US: pat. pending; D651738; CN: ZL201230040341.3; ZL201130028360.X; TW: pat. 101301367; MX: 35699; Pat. pending; CA: © RAB Lighting Inc;

Note: These instructions do not cover all details or variations in equipment nor do they provide for every possible situation during installation, operation or maintenance.



Easy Installation & Product Help

Tech Help Line
Call our experts 888 RAB-1000

rabweb.com
Visit our website for product info

email
Answered promptly sales@rabweb.com

VXBRLED with Globe & Guard INSTRUCTIONS



Thank you for buying RAB lighting fixtures. Our goal is to design the best quality products to get the job done right. We'd like to hear your comments. Call the Marketing Department at 888-RAB-1000 or email: marketing@rabweb.com

VXBRLED13DG Cool

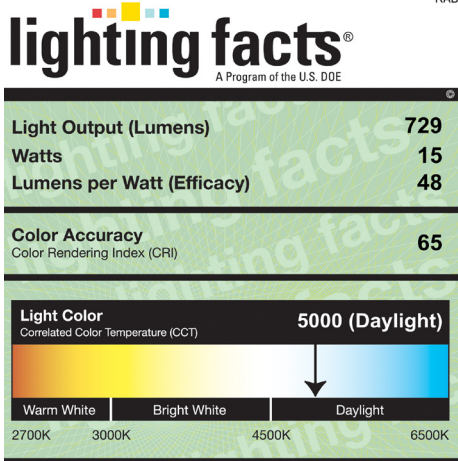

All results are according to IESNA LM-79-2008: *Approved Method for the Electrical and Photometric Testing of Solid-State Lighting*. The U.S. Department of Energy (DOE) verifies product test data and results.

Visit www.lightingfacts.com for the *Label Reference Guide*.

Registration Number: WVMA-C4LN78
Model Number: VXBRLED13DG
Type: Outdoor decorative fixture

VXBRLED13DG Neutral

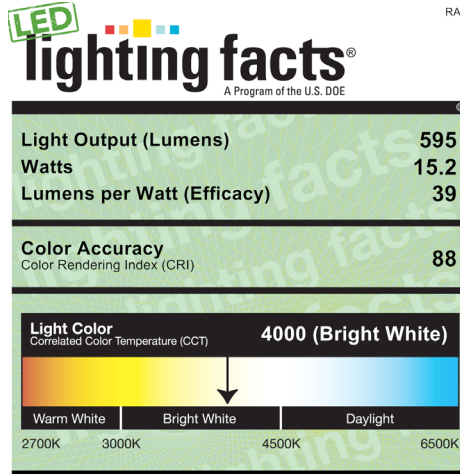

All results are according to IESNA LM-79-2008: *Approved Method for the Electrical and Photometric Testing of Solid-State Lighting*. The U.S. Department of Energy (DOE) verifies product test data and results.

Visit www.lightingfacts.com for the *Label Reference Guide*.

Registration Number: WVMA-6QSCSE (6/9/2012)
Model Number: VXBRLED13NDG
Type: Outdoor decorative fixture

VXBRLED13DG Warm

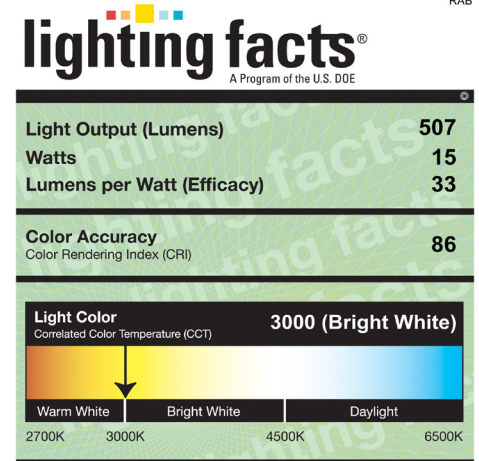

All results are according to IESNA LM-79-2008: *Approved Method for the Electrical and Photometric Testing of Solid-State Lighting*. The U.S. Department of Energy (DOE) verifies product test data and results.

Visit www.lightingfacts.com for the *Label Reference Guide*.

Registration Number: WVMA-VY78JE
Model Number: VXBRLED13YDG
Type: Outdoor decorative fixture

VXBRLED26DG Cool

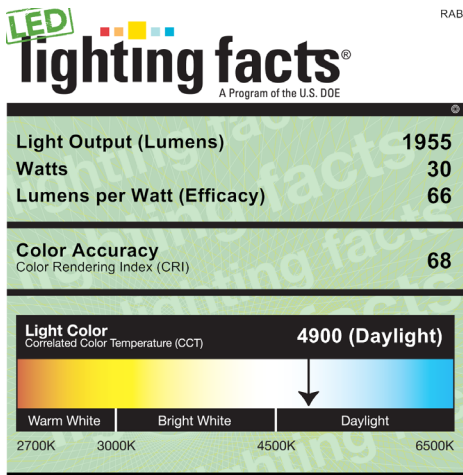

All results are according to IESNA LM-79-2008: *Approved Method for the Electrical and Photometric Testing of Solid-State Lighting*. The U.S. Department of Energy (DOE) verifies product test data and results.

Visit www.lightingfacts.com for the *Label Reference Guide*.

Registration Number: WVMA-YB48YQ (5/3/2012)
Model Number: VXBRLED26DG
Type: Outdoor decorative fixture

VXBRLED26DG Neutral

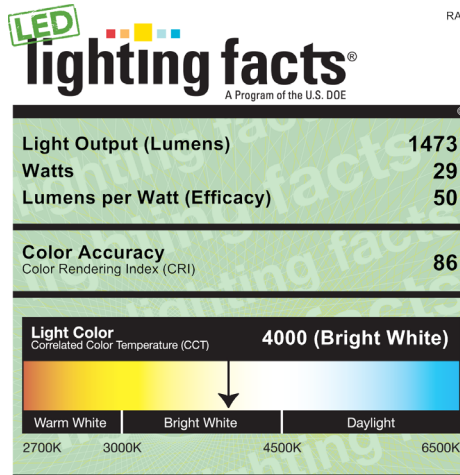

All results are according to IESNA LM-79-2008: *Approved Method for the Electrical and Photometric Testing of Solid-State Lighting*. The U.S. Department of Energy (DOE) verifies product test data and results.

Visit www.lightingfacts.com for the *Label Reference Guide*.

Registration Number: WVMA-M7K76Q (5/3/2012)
Model Number: VXBRLED26NDG
Type: Outdoor decorative fixture

VXBRLED26DG Warm

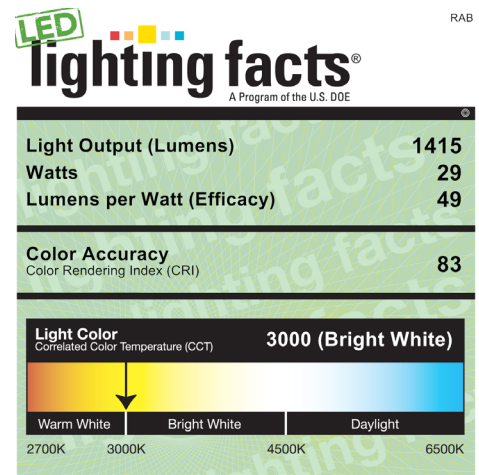

All results are according to IESNA LM-79-2008: *Approved Method for the Electrical and Photometric Testing of Solid-State Lighting*. The U.S. Department of Energy (DOE) verifies product test data and results.

Visit www.lightingfacts.com for the *Label Reference Guide*.

Registration Number: WVMA-R2XF6L (5/3/2012)
Model Number: VXBRLED26YDG
Type: Outdoor decorative fixture