



Partial LED Vaporproof fixture requires RAB Globe and Guard. Can be used with color globes.

Color: Natural

Weight: 5.8 lbs

<b>Project:</b>	<b>Type:</b>
<b>Prepared By:</b>	<b>Date:</b>

Driver Info		LED Info	
Type	Constant Current	Watts	13W
120V	0.13A	Color Temp	4000K (Neutral)
208V	0.08A	Color Accuracy	88 CRI
240V	0.07A	L70 Lifespan	100,000 Hours
277V	0.06A	Lumens	595 lm
Input Watts	15.2W	Efficacy	39.1 lm/W

## Technical Specifications

### Performance

#### Lifespan:

100,000-Hour LED lifespan based on IES LM-80 results and TM-21 calculations

### Construction

#### Specification:

These specifications are for fixture with Frosted Glass Globe and Die Cast Guard combination. Consult warehouse for different fixture combinations.

#### Globes and Guards:

Vaporproof LEDs are compatible with RAB Globes and Guards

#### Construction:

Die cast aluminum housing and door. Tether connects back housing halves for safety.

#### Cold Weather Starting:

The minimum starting temperature is -40°C (-40°F)

#### Ambient Temperature:

Suitable for use in up to 35°C (95°F)

#### Housing:

Die-cast aluminum housing and driver housing

#### Mounting:

Three 1/2"NPS conduit entry points

#### Reflector:

High quality hydroformed semi-specular aluminum

#### Gaskets:

High-temperature Silicone

#### Finish:

Natural shot blasted aluminum

#### Green Technology:

Mercury and UV free. RoHS-compliant components.

### Compliance

#### UL Listed:

Suitable for Wet locations only with outer globe and as a Downlight

#### IESNA LM-79 & lm-80 Testing:

RAB LED luminaires and LED components have been tested by an independent laboratory in accordance with IESNA lm-79 and lm-80

### Electrical

#### Driver:

Multi-chip single 13W high output long life LED Driver. Constant Current, 100V-277V, 50/60 Hz., 100-240VAC. 3-.15 Amps 277VAC. 15 Amps. Will deliver 70% of its initial lumens at 100,000 hours based on lm-80 Tests.

#### Surge Protection:

4kV

### LED Characteristics

#### Color Consistency:

3-step MacAdam Ellipse binning to achieve consistent fixture-to-fixture color

#### Color Stability:

LED color temperature is warranted to shift no more than 200K in color temperature over a 5-year period

#### Color Uniformity:

RAB's range of Correlated Color Temperature follows the guidelines of the American National Standard for Specifications for the Chromaticity of Solid State Lighting (SSL) Products, ANSI C78.377-2017.

### Other

#### Warranty:

RAB warrants that our LED products will be free from defects in materials and workmanship for a period of five (5) years from the date of delivery to the end user, including coverage of light output, color stability, driver performance and fixture finish. RAB's warranty is subject to all terms and conditions found at [rablighting.com/warranty](http://rablighting.com/warranty).

## Technical Specifications (continued)

### Patents:

The VXBRLED design is protected by Taiwan Patent 01510951 and patents pending in the U.S., Canada, China, and Mexico.

### Buy American Act Compliance:

RAB values USA manufacturing! Upon request, RAB may be able to manufacture this product to be compliant with the Buy American Act (BAA). Please contact customer service to request a quote for the product to be made BAA compliant.

### Optical

#### BUG Rating:

B0 U3 G1

## Dimensions

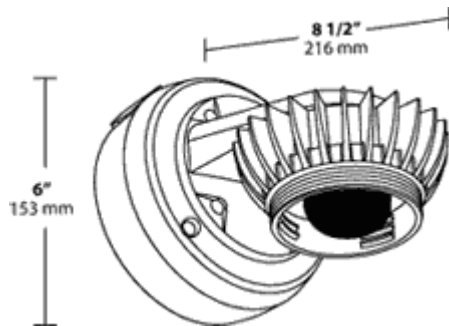

## Features

- High performance LED light engine
- 100,000-hour life based on LM-80 results and TM-21 calculations
- Die Cast Aluminum Housing
- Classic design with state of the art LED technology