



## Technical Specifications (continued)

### Buy American Act Compliance:

RAB values USA manufacturing! Upon request, RAB may be able to manufacture this product to be compliant with the Buy American Act (BAA). Please contact customer service to request a quote for the product to be made BAA compliant.

### Lightcloud

#### Lightcloud Controller Installed:

Integrated/embedded networked lighting control, luminaire-level lighting control. Fixture, Zone, and plug-load control from one powerful device. LLLC - capable of switching, 0-10V dimming, power/energy monitoring. Can also be used to extend the range of the Lightcloud mesh network communication protocols. Offers the capability to set the maximum light output to a less-than-maximum state of an individual luminaire at the time of installation or commissioning. The High-End trim functionality is field reconfigurable via the Lightcloud mesh network communication protocols. The Lightcloud controller can be attached to the fixture, junction box, or electrical panel.

DLC system - NHCZ2BIA17L

[Learn more about Lightcloud.](#)

### Performance

#### Wattage Equivalency:

Equivalent to 200W Metal Halide

## Dimensions

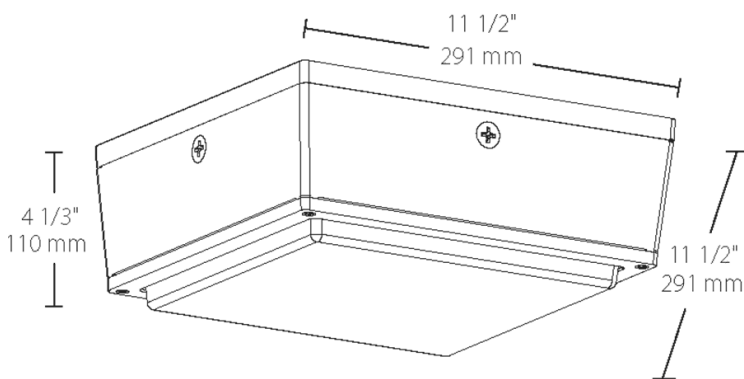

## Features

- Fits the footprint of older canopy lights
- Vandal resistant and UV resistant lens
- Ultra-high efficiency
- Clean, contemporary, low-profile design
- Available with drop lens or flat lens
- IP66 rated, keeps dust, bugs and water out
- Photo and motion sensor options available

## Ordering Matrix

Family	Wattage	Color Temp	Lens-Optics	Finish	Voltage	Options
VANLED	65		FR	W		/LC
	10 = 10W 20 = 20W 28 = 28W 40 = 40W 52 = 52W 65 = 65W 75 = 75W	Blank = 5000K Cool N = 4000K Neutral Y = 3000K Warm	Blank = Drop lens F = Flat lens <sup>1</sup> FR = Frosted Drop Lens FFR = Frosted Flat Lens <sup>1</sup>	Blank = Bronze W = White	Blank = 120-277V, 0-10V Dimming /480 = 480V, 0-10V Dimming	Blank = No Options /E2 = Battery Backup, 120-277V only /LC = Lightcloud® Controller /PCS = 120V Swivel Photocell /PCS2 = 277V Swivel Photocell /PCS4 = 480V Swivel Photocell /WS = Wattstopper, 8ft /WS2 = Wattstopper, 20ft /MVS = Microwave Motion Sensor <sup>1</sup>

<sup>1</sup> /MVS option not available with F and FFR lens