

Technical Specifications (continued)

Ultrasonic Sensor:

Detects the presence of people by sending ultrasonic sound waves and measuring frequency changes caused by movement. They cover the entire space and don't need a line of sight. As a result, they can detect people behind obstacles and are ideal for stairwells in which a line sight is not always possible, and higher levels of sensitivity are required.

Warranty:

RAB warrants that our LED products will be free from defects in materials and workmanship for a period of five (5) years from the date of delivery to the end user, including coverage of light output, color stability, driver performance and fixture finish. RAB's warranty is subject to all terms and conditions found at rablighting.com/warranty.

Buy American Act Compliance:

RAB values USA manufacturing! Upon request, RAB may be able to manufacture this product to be compliant with the Buy American Act (BAA). Please contact customer service to request a quote for the product to be made BAA compliant.

Dimensions

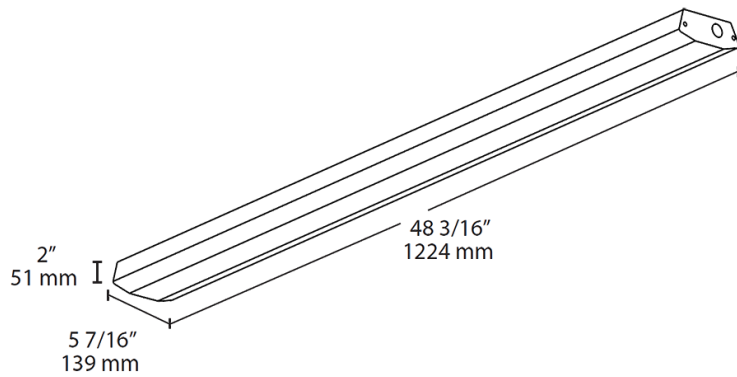

Features

- Diffused lens for smooth light distribution
- 0-10V dimming driver, standard
- 100,000-Hour LED lifespan
- 5-Year, No-Compromise Warranty

Ordering Matrix

Family	Size		Wattage	Color Temp	Dimming	Options
TSLED	4	-	36	N	/D10	/US/BL/E2
	4 = 4 ft 2 = 2 ft		28 = 28W 36 = 36W	Blank = 5000K Cool N = 4000K Neutral YN = 3500K Warm Neutral	/D10 = Dimmable	Blank = No Option /LC = Lightcloud® Controller ¹ /US = Ultrasonic Sensor /US/BL = Ultrasonic Sensor & Bi-Level Operation /E2 = Battery Backup /US/E2 = Ultrasonic Sensor & Battery Backup /US/BL/E2 = Ultrasonic Sensor, Bi-Level Operation & Battery Backup

¹ Only available as a stand-alone option. May not be combined with sensor, bi-level or emergency options.