

INSTRUCTIONS

LED T8 tube series- Hybrid

RAB®

RAB Lighting is committed to creating high-quality, affordable, well-designed and energy-efficient LED lighting and controls that make it easy for electricians to install and end users to save energy. We'd love to hear your comments. Please call the Marketing Department at 888-RAB-1000 or email: marketing@rablighting.com

T8-9-24GC-8XX-HYB
T8-11-36GC-8XX-HYB
T8-14-48GC-8XX-HYB



IMPORTANT

READ CAREFULLY BEFORE INSTALLING LED TUBE. RETAIN THESE INSTRUCTIONS FOR FUTURE REFERENCE.

RAB LED tubes must be wired in accordance with the National Electrical Code and all applicable local codes. Proper grounding is required for safety. THIS PRODUCT MUST BE INSTALLED IN ACCORDANCE WITH THE APPLICABLE INSTALLATION CODE BY A PERSON FAMILIAR WITH THE CONSTRUCTION AND OPERATION OF THE PRODUCT AND THE HAZARDS INVOLVED.

WARNINGS:

SUITABLE FOR DAMP LOCATIONS. DO NOT USE WITH STANDARD DIMMERS, SEE INSTRUCTIONS.

THIS DEVICE IS NOT INTENDED FOR USE WITH EMERGENCY EXITS. NOT FOR USE WITH LIGHT DIMMERS.

THE RETROFIT KIT IS ACCEPTED AS A COMPONENT OF A LUMINAIRE WHERE THE SUITABILITY OF THE COMBINATION SHALL BE DETERMINED BY AUTHORITIES HAVING JURISDICTION. PRODUCT MUST BE INSTALLED BY A QUALIFIED ELECTRICIAN IN ACCORDANCE WITH THE APPLICABLE AND APPROPRIATE ELECTRICAL CODES. THE INSTALLATION GUIDE DOES NOT SUPERSEDE LOCAL OR NATIONAL REGULATIONS FOR ELECTRICAL INSTALLATIONS.

THIS DEVICE COMPLIES WITH PART 15 OF THE FCC RULES. OPERATION IS SUBJECT TO THE FOLLOWING TWO CONDITIONS: (1) THIS DEVICE MAY NOT CAUSE HARMFUL INTERFERENCE, AND(2)THIS DEVICE MUST ACCEPT ANY INTERFERENCE RECEIVED, INCLUDING INTERFERENCE THAT MAY CAUSE UNDESIRE OPERATION.

RISK OF SHOCK-DISCONNECT POWER BEFORE INSTALLATION.

RISK OF FIRE OR ELECTRIC SHOCK. LED RETROFIT KIT INSTALLATION REQUIRES KNOWLEDGE OF LUMINAIRES ELECTRICAL SYSTEMS. IF NOT QUALIFIED, DO NOT ATTEMPT INSTALLATION AND CONTACT A QUALIFIED ELECTRICIAN.

RISK OF FIRE OR ELECTRIC SHOCK. PRODUCT MUST BE INSTALLED IN ACCORDANCE WITH THE NATIONAL ELECTRICAL CODE OR YOUR LOCAL ELECTRICAL CODE. IF YOU ARE NOT FAMILIAR WITH THESE CODES AND REQUIREMENTS, CONTACT A QUALIFIED ELECTRICIAN.

RISK OF FIRE OR ELECTRIC SHOCK. INSTALL THIS KIT ONLY IN THE LUMINAIRES THAT HAVE THE CONSTRUCTION FEATURES AND DIMENSIONS SHOWN IN THE PHOTOGRAPHS AND/OR DRAWINGS AND WHERE THE INPUT RATING OF THE RETROFIT KIT DOES NOT EXCEED THE INPUT RATING OF THE LUMINAIRE.

TO PREVENT WIRING DAMAGE OR ABRASION, DO NOT EXPOSE WIRING TO EDGES OF SHEET METAL OR OTHER SHARP OBJECTS. DO NOT MAKE OR ALTER ANY OPEN HOLES IN AN ENCLOSURE OF WIRING OR ELECTRICAL COMPONENTS DURING KIT INSTALLATION.

TO AVOID POTENTIAL FIRE OR SHOCK HAZARD, DO NOT USE THIS RETROFIT KIT IN LUMINAIRES EMPLOYING SHUNTED BI-PIN LAMP HOLDERS. NOTE: SHUNTED LAMP HOLDERS ARE FOUND ONLY IN FLUORESCENT LUMINAIRES WITH INSTANT-START BALLASTS. INSTANT-START BALLASTS CAN BE IDENTIFIED BY THE WORDS "INSTANT START" OR "I.S." MARKED ON THE BALLAST. THIS DESIGNATION MAY BE IN THE FORM OF A STATEMENT PERTAINING TO THE BALLAST ITSELF, OR MAY BE COMBINED WITH THE MARKING FOR THE LAMPS WITH WHICH THE BALLAST IS INTENDED TO BE USED, FOR EXAMPLE F40T12/IS. FOR MORE INFORMATION, CONTACT THE LED LUMINAIRE RETROFIT KIT MANUFACTURER.

INSTALLERS SHOULD NOT DISCONNECT EXISTING WIRES FROM LAMP HOLDER TERMINALS TO MAKE NEW CONNECTIONS AT LAMP HOLDER TERMINALS. INSTEAD INSTALLERS SHOULD CUT EXISTING LAMP HOLDER LEADS AWAY FROM THE LAMP HOLDER AND MAKE NEW ELECTRICAL CONNECTIONS TO LAMP HOLDER LEAD WIRES BY EMPLOYING APPLICABLE CONNECTORS.

ONLY USE THE CONTROL PROVIDED WITH OR SPECIFIED BY THESE INSTRUCTIONS TO CONTROL THIS LAMP. THIS LAMP WILL NOT OPERATE PROPERLY WHEN CONNECTED TO A STANDARD (INCANDESCENT) DIMMER OR DIMMING CONTROL.

INSTRUCTIONS



LED T8 tube series-Hybrid

RAB Lighting is committed to creating high-quality, affordable, well-designed and energy-efficient LED lighting and controls that make it easy for electricians to install and end users to save energy. We'd love to hear your comments. Please call the Marketing Department at 888-RAB-1000 or email: marketing@rablighting.com

CAUTION - RISK OF FIRE. IF THE LAMP OR LUMINAIRE EXHIBITS UNDESIRABLE OPERATION (BUZZING, FLICKERING, ETC.), IMMEDIATELY TURN OFF POWER, REMOVE LAMP FROM LUMINAIRE AND CONTACT MANUFACTURER.

DO NOT INSTALL THIS LAMP IN A PRE-HEAT LUMINAIRE.

THIS LAMP ONLY OPERATES ON ELECTRONIC BALLASTS. IF LAMP DOES NOT LIGHT WHEN THE LUMINAIRE IS ENERGIZED, REMOVE LAMP FROM LUMINAIRE AND CONTACT LAMP MANUFACTURER OR QUALIFIED ELECTRICIAN.

INSTALLERS SHOULD EXAMINE ALL PARTS THAT ARE NOT INTENDED TO BE REPLACED BY THE RETROFIT KIT FOR DAMAGE AND REPLACE ANY DAMAGED PARTS PRIOR TO INSTALLATION OF THE RETROFIT KIT.

INSTALLATION INSTRUCTIONS - BALLAST COMPATIBLE

1. Turn Power OFF

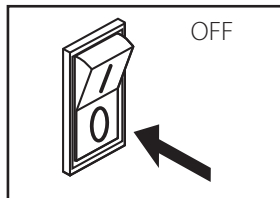

2. Remove lens or diffuser from the luminaire (if applicable)
3. Remove existing fluorescent lamps from the luminaire

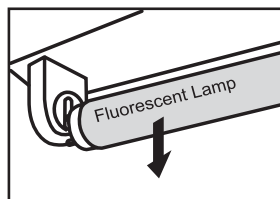
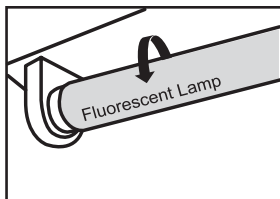

4. Bring LED lamp to the luminaire and insert lamp pins into luminaire lamp holders

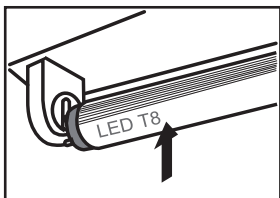

5. Rotate LED lamp until lamp locks in place. Ensure that the LED lamp front points away from the back of the luminaire

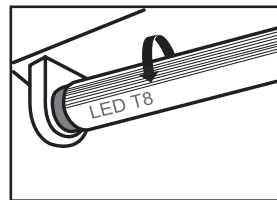

6. Place lens or diffuser back in place (if applicable)
7. Switch power ON

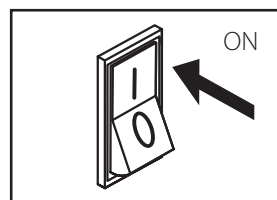

INSTRUCTIONS



LED T8 tube series- Hybrid

RAB Lighting is committed to creating high-quality, affordable, well-designed and energy-efficient LED lighting and controls that make it easy for electricians to install and end users to save energy. We'd love to hear your comments. Please call the Marketing Department at 888-RAB-1000 or email: marketing@rablighting.com

SINGLE-ENDED INSTALLATION- BALLAST BYPASS (Without dimmer)

- 1) Make sure the circuit breaker that supplies the power to the fixture is turned off.
- 2) Remove lens or diffuser cover (if applicable) and existing fluorescent lamps.
- 3) Open/Remove ballast wiring compartment cover.
- 4) Check if there is a ballast in the fixture, if not, please go to step 7.
- 5) Identify the line and neutral wires running from the breaker box to the ballast and confirm the power is off using a voltmeter.
- 6) Cut all wires connected to ballast, and remove ballast (and starter if present). Dispose of removed ballast and fluorescent lamps in accordance with government regulations in your area.
- 7) Identify what type of lampholders are in fixture (Fig.1), If existing lampholder is internally shunted, then replace with new non-shunted lampholder. If lampholder is shunted with a jumper wire (Fig.2), remove wire to convert into non-shunted.
- 8) Wire using appropriate wiring diagram (Fig.3-4).
- 9) Reinstall the ballast cover to hide all wires.
- 10) Install your new LED T8 replacement lamp.
- 11) Apply Warning Label on a visible location inside the fixture.
- 12) Reinstall lens or diffusion cover on the light fixture.
- 13) Turn power on at the breaker box.
- 14) Turn on the lights.

SINGLE-ENDED INSTALLATION- BALLAST BYPASS (Without dimmer) (cont'd)

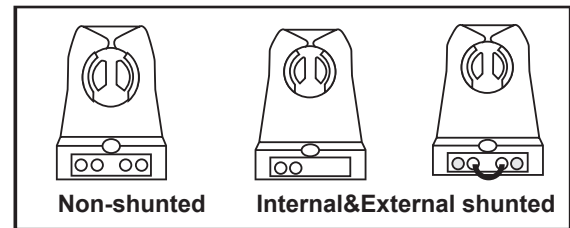

Fig:1 -Lampholder Type

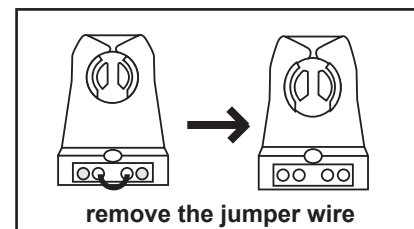

Fig:2 -External shunted Lampholder



Fig:3 - Single lamp wiring

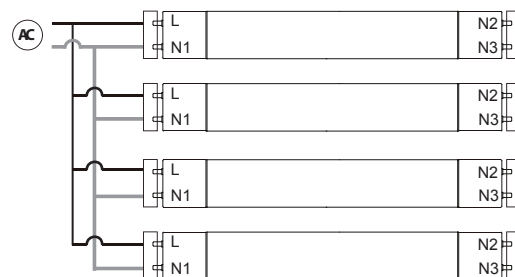

Fig:4 - Multiple lamps wiring

INSTRUCTIONS

LED T8 tube series- Hybrid



RAB Lighting is committed to creating high-quality, affordable, well-designed and energy-efficient LED lighting and controls that make it easy for electricians to install and end users to save energy. We'd love to hear your comments. Please call the Marketing Department at 888-RAB-1000 or email: marketing@rablighting.com

DOUBLE-ENDED INSTALLATION - BALLAST BYPASS (Without dimmer)

- 1) Make sure the circuit breaker that supplies the power to the fixture is turned off.
- 2) Remove lens or diffuser cover (if applicable) and existing fluorescent lamps.
- 3) Open/Remove ballast wiring compartment cover.
- 4) Check if there is a ballast in the fixture, if not, please go to step 7.
- 5) Identify the line and neutral wires running from the breaker box to the ballast and confirm the power is off using a voltmeter.
- 6) Cut all wires connected to ballast, and remove ballast (and starter if present). Dispose of removed ballast and fluorescent lamps in accordance with government regulations in your area.
- 7) Identify what type of lampholders are in fixture (*Fig.1*), Double ended wiring can be used with shunted or non-shunted lampholder.
- 8) Wire using appropriate wiring diagram (*Fig.2-5*).
- 9) Reinstall the ballast cover to hide all wires.
- 10) Install your new LED T8 replacement lamp.
- 11) Apply Warning Label on a visible location inside the fixture.
- 12) Reinstall lens or diffusion cover on the light fixture.
- 13) Turn power on at the breaker box.
- 14) Turn on the lights.

DOUBLE-ENDED INSTALLATION - BALLAST BYPASS (Without dimmer) (cont'd)

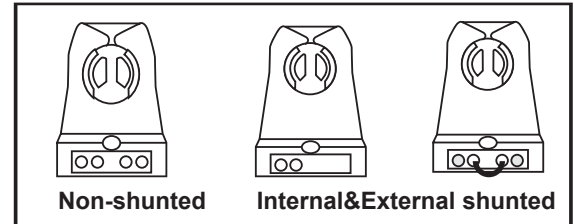

Fig:1 -Lampholder Type

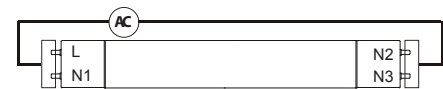

Fig:2 -Single-lamp with shunted lampholder

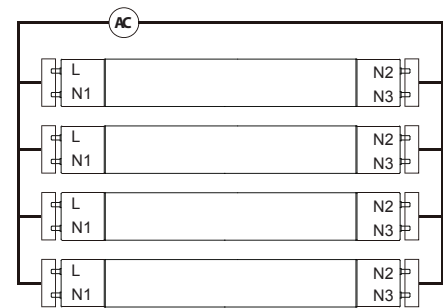

Fig:3 -Multiple-lamps with shunted lampholder

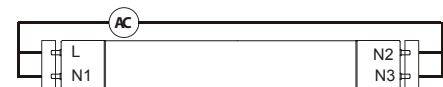

Fig:4 -Single-lamp with non-shunted lampholder

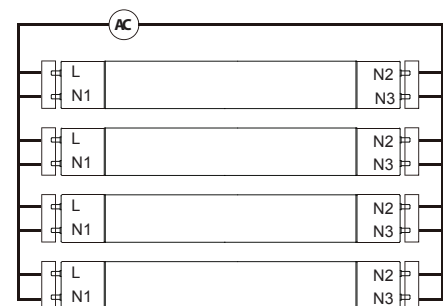

Fig:5 -Multiple-lamps with non-shunted lampholder

Note: These instructions do not cover all details or variations in equipment nor do they provide for every possible situation during installation, operation or maintenance.

INSTRUCTIONS

LED T8 tube series- Single or Double-Ended Bypass



RAB Lighting is committed to creating high-quality, affordable, well-designed and energy-efficient LED lighting and controls that make it easy for electricians to install and end users to save energy. We'd love to hear your comments. Please call the Marketing Department at 888-RAB-1000 or email: marketing@rablighting.com

DOUBLE-ENDED INSTALLATION (With dimmer)

DOUBLE-ENDED INSTALLATION (With dimmer) (cont'd)

- 1) Make sure the power supply is 120VAC/60HZ.
- 2) Make sure the circuit breaker that supplies the power to the fixture is turned off.
- 3) Remove lens or diffuser cover (if applicable) and existing fluorescent lamps.
- 4) Open/Remove ballast wiring compartment cover.
- 5) Check if there is a ballast in the fixture, if not, please go to step 7.
- 6) Identify the line and neutral wires running from the breaker box to the ballast and confirm the power is off using a voltmeter.
- 7) Cut all wires connected to ballast, and remove ballast (and starter if present). Dispose of removed ballast and fluorescent lamps in accordance with government regulations in your area.
- 8) Identify what type of lampholders are in fixture (Fig.1), Double ended wiring can be used with shunted or non-shunted lampholder.
- 9) Wire using appropriate wiring diagram (Fig.2-5).
- 10) Reinstall the ballast cover to hide all wires.
- 11) Install your new LED T5 replacement lamp.
- 12) Apply Warning Label on a visible location inside the fixture.
- 13) Reinstall lens or diffusion cover on the light fixture.
- 14) Turn power on at the breaker box.
- 15) Turn on the lights.

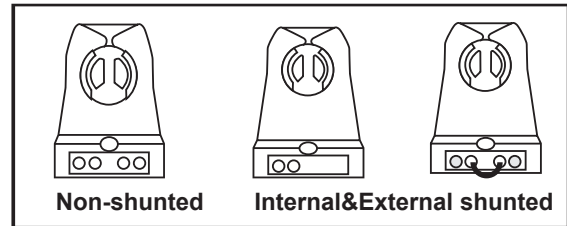

Fig:1 -Lampholder Type

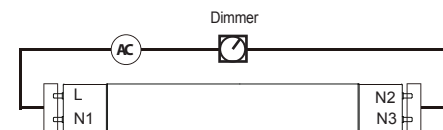

Fig:2 -Single-lamp with shunted lampholder

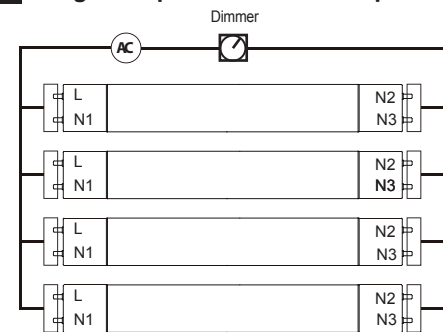

Fig:3 -Multiple-lamps with shunted lampholder

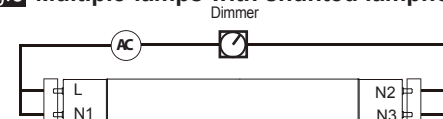

Fig:4 -Single-lamp with non-shunted lampholder

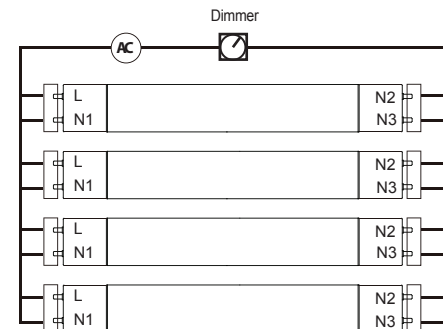

Fig:5 -Multiple-lamps with non-shunted lampholder

Luminaire overall dimensions, cm	Model Number	T8-9-24GC-8XX-HYB	T8-11-36GC-8XX-HYB	T8-14-48GC-8XX-HYB
	Pieces		4	4
Length		61.5	91.5	121.5
Width		60.5	60.5	60.5
Height		10	10	10
Lamp-to-lamp Spacing, cm		11	11	11



Easy Answers

rablighting.com
Visit our website for product info

Tech Help Line
Call our experts: 888 722-1000

e-mail
Answered promptly - sales@rablighting.com

Free Lighting Layouts
Answered online or by request

RAB WARRANTY: RAB's warranty is subject to all terms and conditions found at rablighting.com/warranty.