

INSTRUCTIONS

SWISH® FA - EDGE INSTALLATION



RAB Lighting is committed to creating high-quality, affordable, well-designed and energy-efficient LED lighting and controls that make it easy for electricians to install and end users to save energy. We'd love to hear your comments. Please call the Marketing Department at 888-RAB-1000 or email: marketing@rablighting.com



SWISHFA-EDGE 2X2



SWISHFA-EDGE 2X4

IMPORTANT

READ CAREFULLY BEFORE INSTALLING FIXTURE. RETAIN THESE INSTRUCTIONS FOR FUTURE REFERENCE.

RAB fixtures must be wired in accordance with the National Electrical Code and all applicable local codes. Proper grounding is required for safety. THIS PRODUCT MUST BE INSTALLED IN ACCORDANCE WITH THE APPLICABLE INSTALLATION CODE BY A PERSON FAMILIAR WITH THE CONSTRUCTION AND OPERATION OF THE PRODUCT AND THE HAZARDS INVOLVED.

WARNING: Make certain power is OFF before installing or maintaining fixture. No user serviceable parts inside.

RECESSED CEILING MOUNTING

The fixture is suitable only for **INDOOR RECESSED CEILING** application. Above ceiling access required.

To mount in an insulated or non-insulated ceiling - 9/16" or 15/16" exposed Flat Tee Grid Ceiling follow the steps below.

1. Rotate and slide the **Housing** as required to fit through the **Tee-Grid Bar** and place it as indicated by the directional arrow as shown in Fig. 1.
2. Firmly bend the pre-installed **Grid Clips (4)** against the **Tee-Grid Bar** to secure the **Housing** as shown in Fig. 2
3. **Support Wires** are required by installation codes. Support the **Housing** to the building structure by **Support Wires** (supplied by others) through the **Support Wire Hole** as shown in Fig. 3.
4. Make sure that the orientation of the **Access Plate** faces an accessible tile to make electrical splices.
5. Loosen screw on **Access Plate** and remove the **Access Plate** (Fig. 1). Knock out appropriate **Conduit Knockouts** on the **Access Plate** to route input conduit. Use appropriate conduit connectors as required by code.
6. Connect wires as shown in wiring diagram (Fig 4). Push all wires back into the **Splice Box**. Be careful not to pinch wires. **WARNING: To prevent wiring damage or abrasion, do not expose wiring to edges of sheet metal or other sharp objects.**
7. Replace **Access Plate** and tighten **Access Plate Screw**.
8. After installation remove protective film from the outer surface of the lens.

Fig: 1

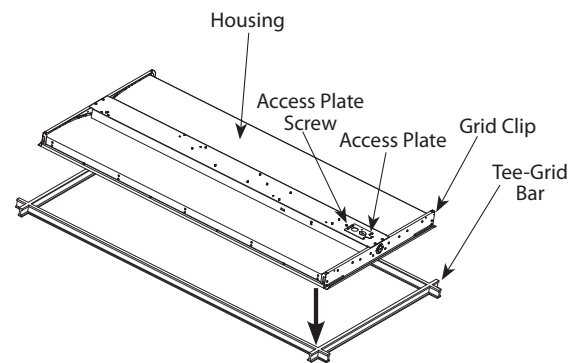

Fig: 2

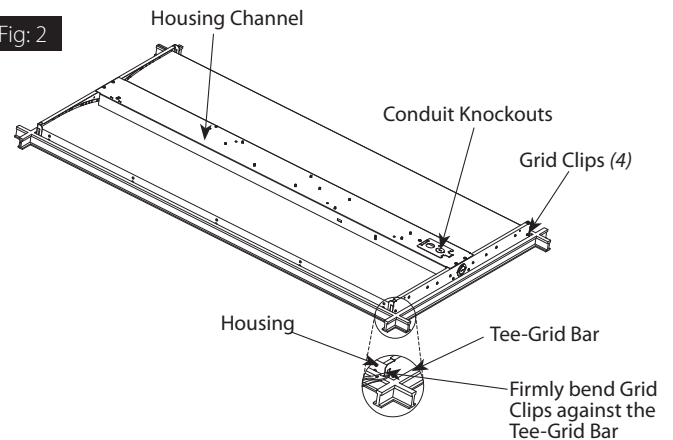
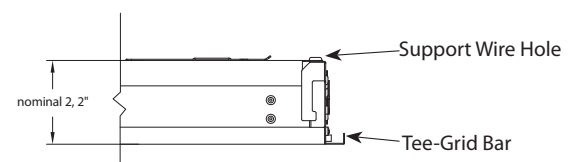

Fig: 3



INSTRUCTIONS

SWISH® FA - EDGE INSTALLATION



RAB Lighting is committed to creating high-quality, affordable, well-designed and energy-efficient LED lighting and controls that make it easy for electricians to install and end users to save energy. We'd love to hear your comments. Please call the Marketing Department at 888-RAB-1000 or email: marketing@rablighting.com

FIELD ADJUSTMENT

Follow instructions below to change the fixture power from the factory settings. Factory Settings: 29W (2x2) 39W (2x4)

1. Locate the **Power Selection Switch** on the side of the **Housing Channel** as shown in Fig 4.
2. Select the desired power by sliding the respective **Power Selection Switch** up or down to the desired value (Fig 5).

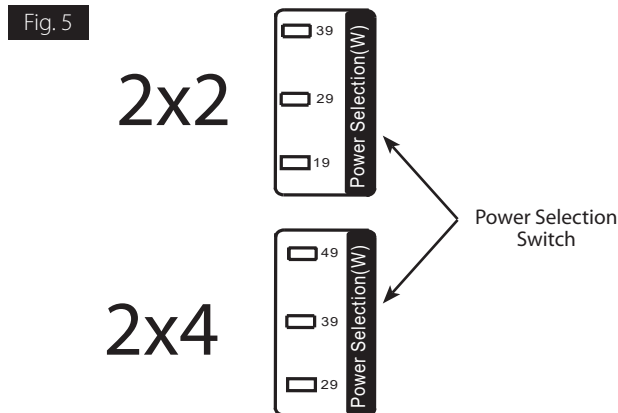
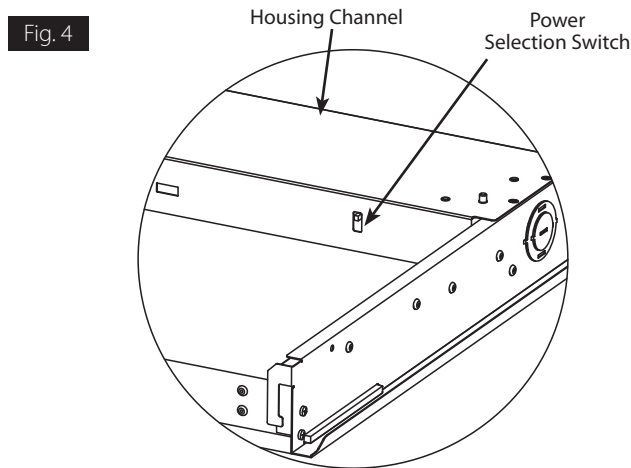

LIGHTCLOUD® BLUE

Lightcloud Blue is a Bluetooth mesh wireless lighting control system that allows you to control various compatible devices. With RAB's patented Rapid Provisioning technology, devices can be quickly and easily commissioned for residential and large commercial applications using the Lightcloud Blue mobile app.

Each device in a system can communicate with any other device, eliminating the need for a Gateway or Hub and maximizing the control system's reach.

Lightcloud Blue devices should be placed within the specified range to communicate within the Bluetooth Mesh network. Up to 60 feet between standard building materials. Up to 200 feet clear line of sight.

Reset to Factory Settings: To enable pairing or reset the device, locate the device identification button at the top of the Controller under the Lightcloud logo. Press and hold this button for 10 seconds or until the indicator light begins flashing red, and the fixture will also on/off 5 times.

LED Indicators:

Blinking Red = Looking for a network

Solid Green = Connected to network

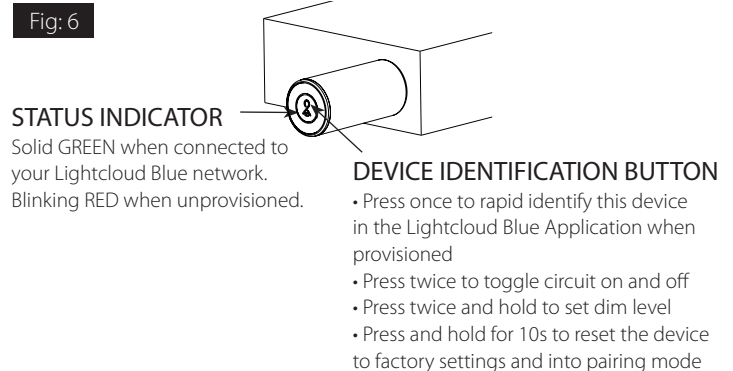

0-10V DIMMABLE WIRING

Universal voltage driver permits operation at 120V through 277V, 50 or 60 Hz. 0-10V control wires must be rated for 300V minimum. For 0-10V dimming follow the wiring directions shown in Fig. 7.

1. Connect the black fixture lead to the **LINE** supply lead.
2. Connect the white fixture lead to the **COMMON** supply lead
3. Connect the **GROUND** wire from fixture to supply **GROUND**. Do NOT connect the **GROUND** of the dimming fixture to the output.
4. Connect the purple fixture lead to the (V+) DIM lead.
5. Connect the pink fixture lead to the (V-) DIM lead.

INSTRUCTIONS

SWISH® FA - EDGE INSTALLATION



RAB Lighting is committed to creating high-quality, affordable, well-designed and energy-efficient LED lighting and controls that make it easy for electricians to install and end users to save energy. We'd love to hear your comments. Please call the Marketing Department at 888-RAB-1000 or email: marketing@rablighting.com

Fig. 7

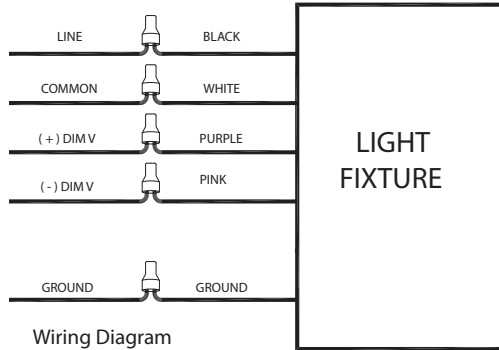

CONTROLLING LIGHTCLOUD® BLUE DEVICE

1. Confirm your device is powered on.
2. Download the Lightcloud Blue app from the Apple App Store or Google Play store.
3. Launch the App and create an account or sign into an existing account.
4. Tap the "add device" icon in the app to start connecting devices.
5. Follow the remaining steps in the app. Create areas, groups, and scenes to organize and control your devices.
6. You're all set!

WIRING

WARNING: Lightcloud Blue-enabled fixtures require constant power and shouldn't be placed down circuit from any switching devices.

Universal voltage driver permits operation at 120V thru 277V, 50 or 60 Hz. For 0-10V Dimming, follow the wiring directions shown in (Fig. 8).

1. Connect the **Black** fixture lead to the LINE supply lead.
2. Connect the **White** fixture lead to the COMMON supply lead.
3. Connect the **GROUND** wire from fixture to supply ground.
4. Connect the **Purple** wire from fixture to supply ground.
5. Connect the **Pink (Grey)** wire from fixture to supply ground.

Fig. 8

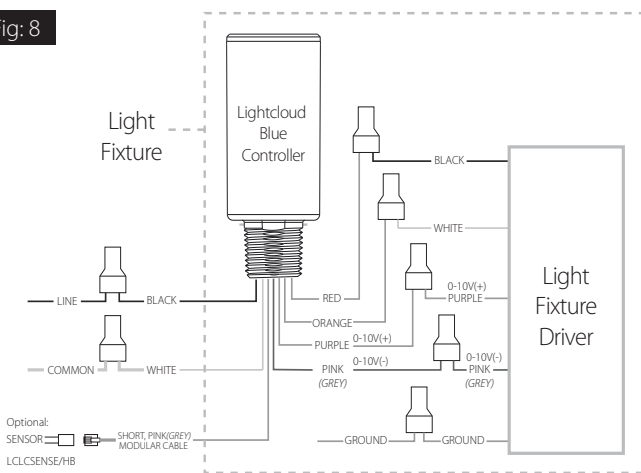

NOTE: Do not connect DIM V+ (purple)/ DIM V- (pink(grey)) to line voltage or supply ground.

To test, double click the Lightcloud Blue button to turn on and off the fixture shown in (Fig. 6).

SENSOR SETUP & INSTALLATION

1. The PIR Sensor is only compatible with select sensor-ready fixtures. Visit www.rablighting.com to see the full compatibility list.
2. Remove Bezel: Twist counter-clockwise (Fig. 9).
3. Prepare Mounting Hole: Use knockout or cut hole for sensor. Holes have +/- 1/8 in. tolerance (Fig. 10).
4. In-Fixture Mounting: Place gasket and sensor through the hole cut (Fig. 11).
5. Connect the Sensor Lightcloud Blue Controller: Use the adapter to connect the sensor to the controller.
6. Plug both RJ09 from Sensor and Controller to adapter.

Fig. 9

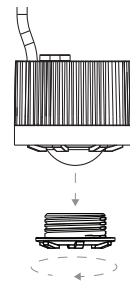

Fig. 10

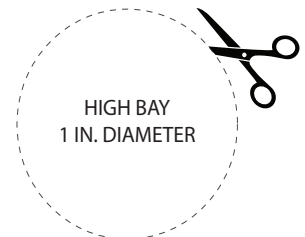

Fig. 11

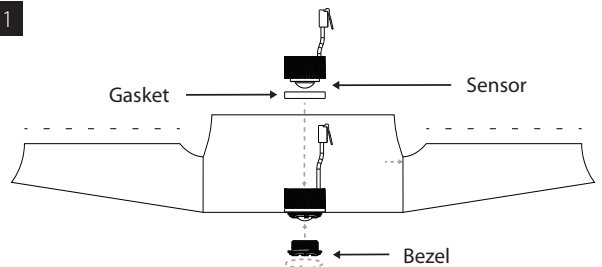
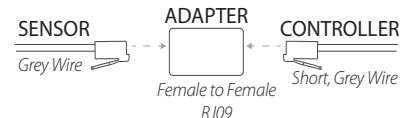

Fig. 12



INSTRUCTIONS

SWISH® FA - EDGE INSTALLATION



RAB Lighting is committed to creating high-quality, affordable, well-designed and energy-efficient LED lighting and controls that make it easy for electricians to install and end users to save energy. We'd love to hear your comments. Please call the Marketing Department at 888-RAB-1000 or email: marketing@rablighting.com

SENSOR COVERAGE

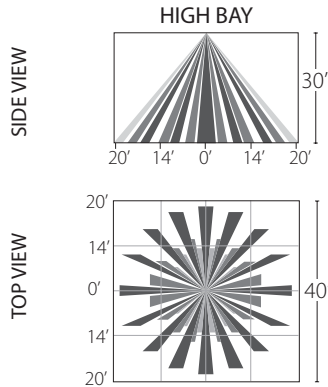

CONFIGURATION

To configure the Lightcloud Blue please login to the Lightcloud Blue app for details. For additional startup information, please visit www.lightcloud.com/item/lcb-getting-started/

CLEANING & MAINTENANCE

CAUTION: Be sure fixture temperature is cool enough to touch. Do not clean or maintain while fixture is energized.

1. Clean polystyrene lens & fixture with non-abrasive cleaning solution.
2. Do not open fixture to clean the LEDs. Do not touch the LEDs.

TROUBLESHOOTING

1. Check that the line voltage at the fixture is correct. Refer to wiring directions.
2. Is the fixture grounded properly?

INSTRUCTIONS

SWISH® FA - EDGE INSTALLATION



RAB Lighting is committed to creating high-quality, affordable, well-designed and energy-efficient LED lighting and controls that make it easy for electricians to install and end users to save energy. We'd love to hear your comments. Please call the Marketing Department at 888-RAB-1000 or email: marketing@rablighting.com

BATTERY BACKUP MODELS

WIRING

CAUTION: FOR BATTERY BACKUP FIXTURE. Voltage can be present in **BATTERY**. To prevent high voltage from being present on output leads, Inverter connector must be open. Do not join **BATTERY** connector until installation is complete and AC power is supplied to the emergency driver (Fig. 13).

NOTE: Make sure that the necessary branch circuit wiring is available. An **UNSWITCHED** AC source of power is required. The emergency driver must be fed from the same branch circuit as the LED driver.

CAUTION: Do not use any supply voltage other than 120-277V 50/60 HZ.

1. Connect **UNSWITCHED HOT** fixture lead to **HOT AC** supply line.
2. If using an **UNSWITCHED** circuit, connect **UNSWITCHED** and **SWITCHED** lines together.
3. If using a **SWITCHED** circuit, connect **SWITCHED HOT** AC fixture lead to the external.
4. For 0-10V dimming connect **DIM (+)** purple and **DIM (-)** pink leads to dimming circuit.
5. After installation is complete supply AC power to the fixture and connect the **BATTERY**.
6. When power is on the fixture should be on and the Charging Indicator Light should illuminate to indicate the battery is charging.
7. Once the **BATTERY** has charged for at least one hour a short duration test may be performed by pressing the test button.
8. After the battery has charged for 24 hours a long duration test can be performed by shutting power to the fixture.

Fig: 13

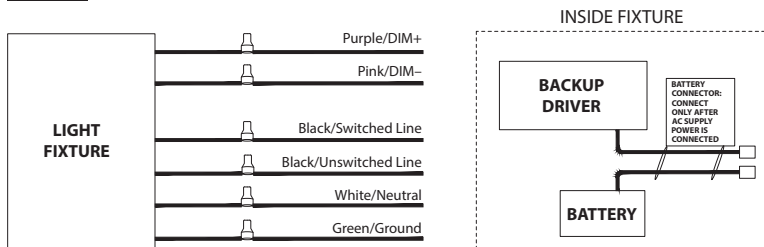

Note: These instructions do not cover all details or variations in equipment nor do they provide for every possible situation during installation, operation or maintenance.

OPERATION

1. When AC power is applied, the charging indicator light is illuminated, indicating that the **BATTERY** is being charged.
2. When power fails the standby power automatically switches to emergency power (*internal battery*) operating at reduced illumination. The emergency driver supplies standby power for a minimum of 90 minutes.
3. When AC power is restored, the emergency driver automatically returns to charging mode.

MAINTENANCE

Although no routine maintenance is required to keep the emergency driver functional, it should be checked periodically to ensure that it is working. The following schedule is recommended:

1. Visually inspect the charging indicator light monthly. It should be illuminated.
2. Test the emergency operation of the fixture at 30-day intervals for a minimum of 30 seconds.
3. Conduct a 90-minute discharge test once a year. Fixture would operate at reduced illumination for a minimum of 90 minutes.

TROUBLESHOOTING

1. Is the fixture grounded properly?
2. If the charging indicator light does not illuminate after pressing the test button, check if battery is connected properly.



© 2024 RAB LIGHTING INC.

Easy Answers

rablighting.com
Visit our website for product info

Tech Help Line
Call our experts: 888 722-1000

e-mail
Answered promptly - sales@rablighting.com

Free Lighting Layouts
Answered online or by request