

# INSTALLATION INSTRUCTIONS

## SWISH<sup>®</sup>34 2X2, 2X4

# RAB<sup>®</sup>

RAB Lighting is committed to creating high-quality, affordable, well-designed and energy-efficient LED lighting and controls that make it easy for electricians to install and end users to save energy. We'd love to hear your comments. Please call the Marketing Department at 888-RAB-1000 or email: [marketing@rablighting.com](mailto:marketing@rablighting.com)



SWISH34 2x2



SWISH34 2x4

### IMPORTANT

#### READ CAREFULLY BEFORE INSTALLING FIXTURE. RETAIN THESE INSTRUCTIONS FOR FUTURE REFERENCE.

RAB fixtures must be wired in accordance with the National Electrical Code and all applicable local codes. Proper grounding is required for safety. THIS PRODUCT MUST BE INSTALLED IN ACCORDANCE WITH THE APPLICABLE INSTALLATION CODE BY A PERSON FAMILIAR WITH THE CONSTRUCTION AND OPERATION OF THE PRODUCT AND THE HAZARDS INVOLVED.

**WARNING: Make certain power is OFF before installing or maintaining fixture. No user serviceable parts inside.**

### RECESSED CEILING MOUNTING

The fixture is suitable only for indoor recessed ceiling application. Above ceiling access required.

To mount in an insulated or non-insulated ceiling - 9/16" or 15/16" exposed flat tee grid ceiling follow the steps below.

1. Firmly bend the pre-installed **Grid Clips** (*up and out as shown in Fig. 1*).
2. Rotate and slide the **Fixture** as required to fit through the **Tee-Grid Bar** and place it as indicated by the directional arrow as shown in Fig. 2. Secure the **Fixture** to the **Tee-Grid Bar**.
3. Support wires are required by installation Codes. Support the **Fixture** to the building structure by **Support Wires** (*supplied by others*) through the **Grid Clip Hole** as shown in Fig. 2.
4. Make sure that the orientation of the **Splice Box** and **Access Plate** faces an accessible tile to make electrical splices.
5. Loosen **Access Plate Screw** and remove the **Access Plate**. Knock out appropriate **Conduit Knockouts** on the **Access Plate** to route input conduit. Use appropriate conduit connectors as required by code (*Fig. 3*).
6. Connect wires as shown in wiring diagram (*Fig. 4*). Push all wires back into the **Splice Box**. Use appropriate UL approved wire connectors as required by code to complete wiring. Be careful not to pinch wires. **WARNING: To prevent wiring damage or abrasion, do not expose wiring to edges of sheet metal or other sharp objects.**
7. Replace **Access Plate** and tighten **Access Plate Screw**.

Fig: 1

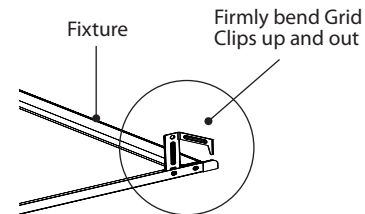

Fig: 2

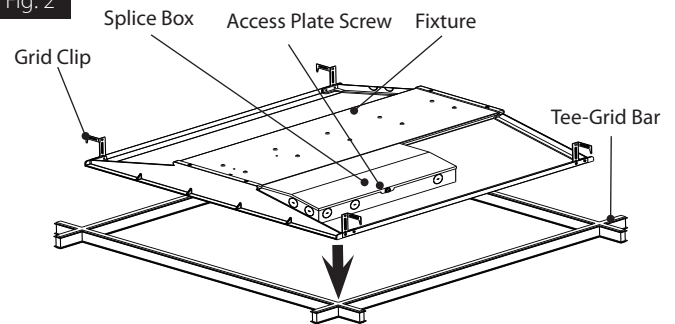
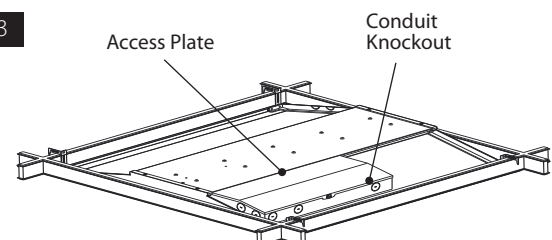

Fig: 3



# INSTALLATION INSTRUCTIONS

## SWISH®34 2X2, 2X4



RAB Lighting is committed to creating high-quality, affordable, well-designed and energy-efficient LED lighting and controls that make it easy for electricians to install and end users to save energy. We'd love to hear your comments. Please call the Marketing Department at 888-RAB-1000 or email: [marketing@rablighting.com](mailto:marketing@rablighting.com)

### SAFETY INSTRUCTIONS

**WARNING:** Risk of fire or electric shock. Suitable for Damp locations.

**WARNING:** Suitable for 9/16" or 15/16" Flat Tee Grid in both Insulated Ceilings and Non-Insulated Ceilings. Access above ceiling required.

**WARNING:** Do not handle energized fixture when hands are wet, when standing on wet or damp surfaces, or in water.

**WARNING:** Vapor barrier must be suitable for 90° C.

**WARNING:** Fixture to be independently supported to building structure.

### 0-10V DIMMABLE WIRING

Universal voltage driver permits operation at 120V thru 277V, 50 or 60 Hz. For 0-10V Dimming, follow the wiring directions as shown in below (Fig. 4).

Do not use any supply voltage other than 120V-277V.

1. Insert the **LINE** supply lead into the black push connector.
2. Insert the **COMMON** supply lead into the white push connector.
3. Insert the **GROUND** supply lead into the green push connector.
4. Insert Dim+ supply lead into the purple push connector.
5. Insert Dim- supply lead into the pink (or gray) push connector.

### CLEANING

**CAUTION: Be sure fixture temperature is cool enough to touch. Do not clean or maintain while fixture is energized.**

1. Clean polystyrene lens & fixture with non-abrasive cleaning solution.
2. Do not open fixture to clean the LEDs. Do not touch the LEDs.

### TROUBLESHOOTING

1. Check the line voltage at fixture. Refer to wiring directions.
2. Is the fixture grounded properly?

Fig. 4

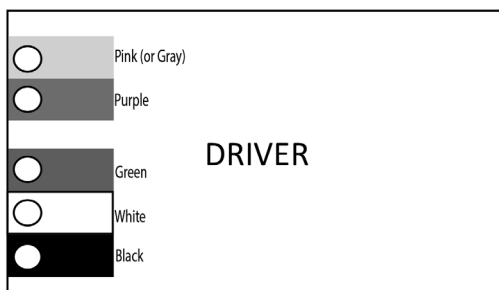

**Note:** These instructions do not cover all details or variations in equipment nor do they provide for every possible situation during installation, operation or maintenance.

# INSTALLATION INSTRUCTIONS

## SWISH34™ 2X2, 2X4



RAB Lighting is committed to creating high-quality, affordable, well-designed and energy-efficient LED lighting and controls that make it easy for electricians to install and end users to save energy. We'd love to hear your comments. Please call the Marketing Department at 888-RAB-1000 or email: [marketing@rablighting.com](mailto:marketing@rablighting.com)

# BATTERY BACKUP MODELS

## WIRING

**CAUTION: FOR BATTERY BACKUP FIXTURE.** Voltage can be present in **BATTERY**. To prevent high voltage from being present on output leads, Inverter Connector must be open. Do not join **BATTERY** connector until installation is complete and AC power is supplied to the emergency driver. (Fig. 5)

**NOTE:** Make sure that the necessary branch circuit wiring is available. An **UNSWITCHED** AC source of power is required. The emergency driver must be fed from the same branch circuit as the LED driver.

**CAUTION:** Do not use any supply voltage other than 120-277V 50/60 HZ.

1. Connect **UNSWITCHED HOT** fixture lead to **HOT AC** supply line.
2. If using an **UNSWITCHED** circuit, connect **UNSWITCHED** and **SWITCHED** lines together.
3. If using a **SWITCHED** circuit, connect **SWITCHED HOT** AC fixture lead to the external.
4. Connect the pink (or gray) fixture lead to the (V-) DIM lead.
5. For 0-10V Dimming, connect **DIM (+)** and **DIM (-)** to the supply ground. Do not connect **GROUND** to the output leads.
6. All unused leads must be capped and insulated.
7. After installation is complete, supply AC power to the fixture and connect the **BATTERY**.
8. When power is on, the fixture should be on and the Charging Indicator Light should illuminate to indicate the battery is charging.
9. Once the **BATTERY** has charged for at least one hour, a short duration test may be performed by pressing the test button.
10. After the battery has charged for 24 hours, a long duration test can be performed by shutting power to the fixture.

FIG. 5

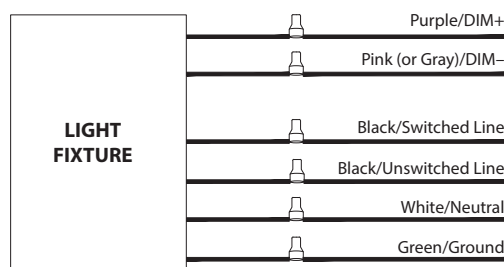

## OPERATION

1. When AC power is applied, the charging indicator light is illuminated, indicating that the **BATTERY** is being charged.
2. When power fails, the standby power automatically switches to emergency power (*internal battery*), operating at reduced illumination. The emergency driver supplies 8W of power for SWISH 2X2 and 16W of power for SWISH 2X4 in standby power for a minimum of 90 minutes.
3. When AC power is restored, the emergency driver automatically returns to charging mode.

## MAINTENANCE

Although no routine maintenance is required to keep the emergency driver functional, it should be checked periodically to ensure that it is working. The following schedule is recommended:

1. Visually inspect the charging indicator light monthly. It should be illuminated.
2. Test the emergency operation of the fixture at 30-day intervals for a minimum of 30 seconds.
3. Conduct a 90-minute discharge test once a year. Fixture will operate at reduced illumination for a minimum of 90 minutes.

## TROUBLESHOOTING

1. Is the fixture grounded properly?
2. If the charging indicator light does not illuminate after pressing the test button, check if battery is connected properly.

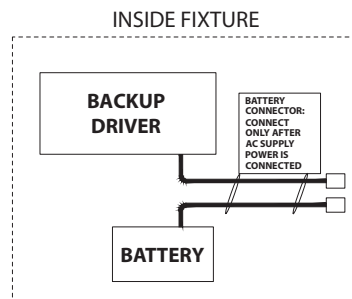

*Note: These instructions do not cover all details or variations in equipment nor do they provide for every possible situation during installation, operation or maintenance.*



© 2022 RAB LIGHTING Inc.

SWISH34 2X2, 2X4 - 1221  
73696-RAB

### Easy Answers

[rablighting.com](http://rablighting.com)  
Visit our website for product info

Tech Help Line  
Call our experts: 888 722-1000

e-mail  
Answered promptly - [sales@rablighting.com](mailto:sales@rablighting.com)

Free Lighting Layouts  
Answered online or by request

**RAB WARRANTY:** RAB'S Warranty is subject to all terms and conditions found at [rablighting.com/warranty](http://rablighting.com/warranty).

# Welcome



Lightcloud®  
Luminaire Sensor

WE'RE HERE TO HELP:

1 (844) LIGHTCLOUD  
or 1 (844) 544-4825

# Hello

The Lightcloud Luminaire Sensor is a dual-technology motion detector and closed loop daylight harvester that can switch and dim both local and remote circuits. The Luminaire Sensor requires a compatible lightcloud controller or fixture.

## Specifications

### PART NUMBER

Edge: LCLCSENSE/EG  
Standard: LCLCSENSE/SH  
High Bay: LCLCSENSE/HB

### INPUT

5VDC

### OPERATING TEMPERATURE

-40°C to 40°C

### DIMENSIONS

Ceiling Mount: 2.25"W x 1.74"H x 2.25"D  
Edge: 1.30"W x 0.99"H x 2.34"D  
Standard: 1.20"W x 1.05"H x 1.20"D  
High Bay: 1.75"W x 1.08"H x 1.75"D

### SENSOR COVERAGE

Edge: 20 ft. diameter at 9 ft.  
Standard: 30 ft. diameter at 9 ft.  
High Bay: 40 ft. diameter at 30 ft.  
50 ft. diameter at 45 ft.

### MOUNTING HEIGHT

Edge: 8 to 12 ft.  
Standard: 8 to 12 ft.  
High Bay: 25 to 45 ft.

### CONNECTOR

RJ9 (RJ22)

### RATING

Standard and High Bay: IP66

# Setup & Installation

- 1 Remove Bezel  
Twist counter-clockwise.

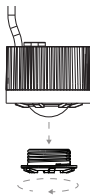

- 2 Prepare Mounting Hole  
Use knockout or cut hole for sensor.  
*Holes have +/- 1/8 in. tolerance.*

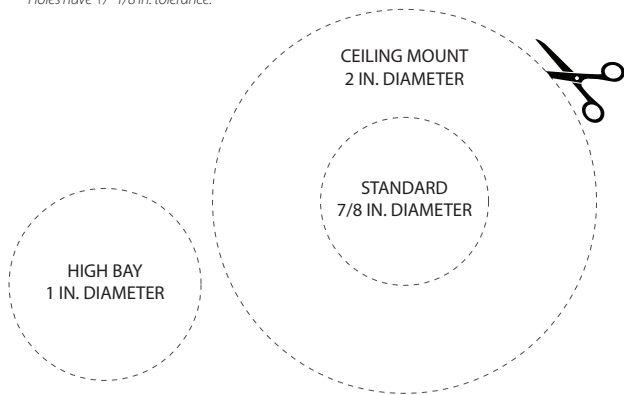

③ Installing the Sensor

3a Ceiling Mount

Place gasket and sensor into ceiling mount.

Screw bezel onto sensor from below ceiling.

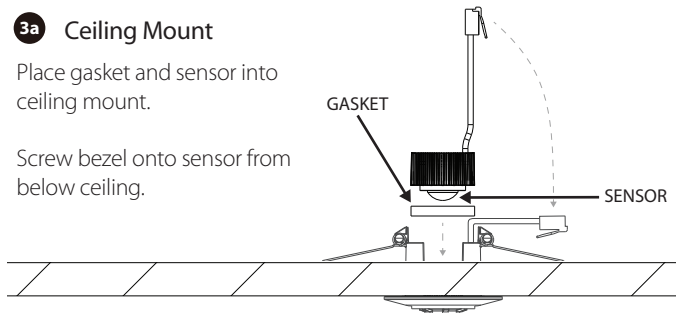

Fold up tabs on ceiling mount and push through hole cut in step 2.

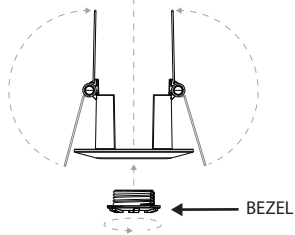

### 3b In-Fixture Mounting

Place gasket and sensor through the hole cut in step 2.

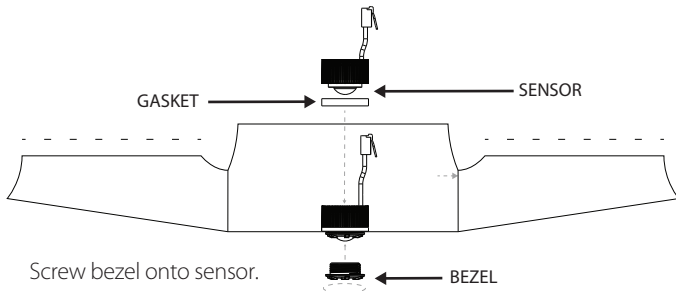

Screw bezel onto sensor.

### 3 Connect the Sensor

**Controller:** Use the adapter to connect the sensor to the Controller.

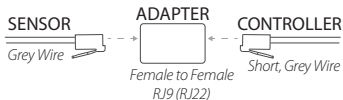

**Lightcloud Driver:** Plug the sensor into the sensor port on the driver.

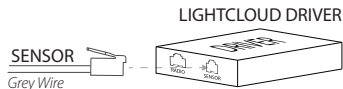

*If a longer cable is needed, an extension cable (RJ9) up to 10 ft. can be used.*



# Configuration

To configure the Luminaire Sensor, please login to the Web App at [control.lightcloud.com](http://control.lightcloud.com) or call Lightcloud Support at 1(844) Lightcloud.

For additional startup information, please visit [lightcloud.com/start](http://lightcloud.com/start).

## Sensor Coverage

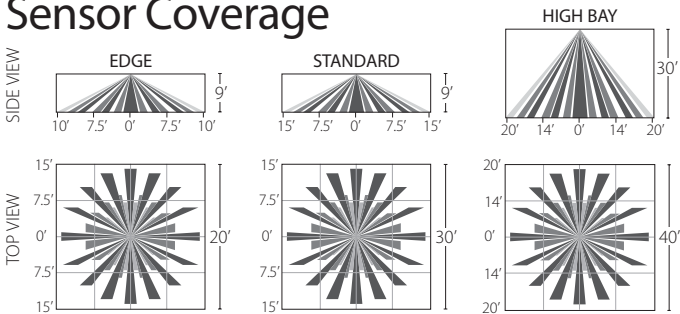

# RAB<sup>®</sup>

© RAB Lighting, Inc. 2020

170 Ludlow Ave., Northvale, NJ 07647  
Custom manufactured in China

WE'RE HERE TO HELP:

1 (844) LIGHTCLOUD  
or 1 (844) 544-4825