

Technical Specifications (continued)

Lightcloud

Lightcloud Blue Installed:

Integrated/embedded networked lighting control, luminaire-level lighting control. Fixture, Zone, and plug-load control from one powerful device. LLLC - capable of switching, 0-10V dimming, power/energy monitoring. Can also be used to extend the range of the Lightcloud Blue utilizes a "BLE Mesh" network communication protocols. Offers the capability to set the maximum light output to a less-than-maximum state of an individual luminaire at the time of installation or commissioning. The High-End trim functionality is field reconfigurable via the Lightcloud "BLE Mesh" network communication protocols. The Lightcloud Blue controller is designed to be attached to the fixture directly.

DLC system - N1XMLOEATBA

[Learn more about Lightcloud.](#)

Other

Warranty:

RAB warrants that our LED products will be free from defects in materials and workmanship for a period of five (5) years from the date of delivery to the end user, including coverage of light output, color stability, driver performance and fixture finish. RAB's warranty is subject to all terms and conditions found at rablighting.com/warranty.

Patents:

This design is protected by patents pending in US, Canada, China, Taiwan and Mexico

Buy American Act Compliance:

RAB values USA manufacturing! Upon request, RAB may be able to manufacture this product to be compliant with the Buy American Act (BAA). Please contact customer service to request a quote for the product to be made BAA compliant.

Dimensions

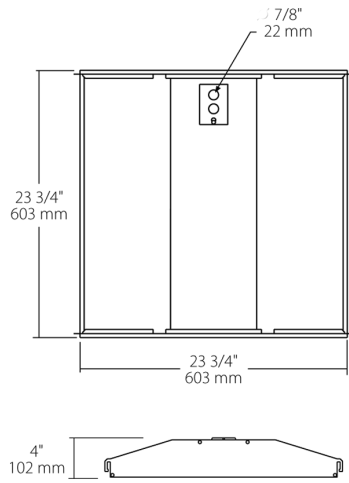

Features

- Direct Connect to the Lightcloud Blue mobile app via Bluetooth, no Gateway or Hub required
- Use mobile device to configure features for On/Off Control, Dim Level, Schedules, Scenes, and more.
- Meets Luminaire Level Lighting Control (LLLC) requirements
- Integrated passive infrared or microwave sensor for added savings
- Use mobile device to configure sensor settings for sensitivity, timeout and actions.
- Emergency battery backup options available

Ordering Matrix

Family	Size	Wattage	Color Temp	Driver	Options	Chicago Penum	
SWISH	2X2	-	29	N	/D10	/LCB	
	2X4 = 2' x 4' 2X2 = 2' x 2'	19 = 19W (2x2) 29 = 29W (2x2) 39 = 39W (2x4) 49 = 49W (2x4)	Blank = 5000K Cool N = 4000K Neutral YN = 3500K Warm Neutral Y = 3000K Warm	/D10 = 0-10V Dimming	/E2 = Battery Backup /LC = Lightcloud® Controller /LCB = Lightcloud® Blue Enabled /LCBS = Lightcloud® Blue Enabled w/ PIR Sensor /MVS = Microwave Occupancy Sensor /LC/E2 = Lightcloud® Controller w/ Battery Backup /LCB/E2 = Lightcloud® Blue Enabled and Battery Backup /LCBS/E2 = Lightcloud® Blue Enabled w/ PIR Sensor and Battery Backup /LCBS/MVS = Lightcloud® Blue Enabled w/ MVS Sensor /LCBS/MVS/E2 = Lightcloud® Blue Enabled w/ MVS Sensor and Battery Backup /MVS/E2 = Microwave Occupancy Sensor w/ Battery Backup Blank = No Option	Blank = Standard /CP = Chicago Plenum	