

Technical Specifications (continued)

Performance

Lifespan:

100,000-Hour LED lifespan based on IES LM-80 results and TM-21 calculations

Other

Warranty:

RAB warrants that our LED products will be free from defects in materials and workmanship for a period of five (5) years from the date of delivery to the end user, including coverage of light output, color stability, driver performance and fixture finish. RAB's warranty is subject to all terms and conditions found at rablighting.com/warranty.

Patents:

This design is protected by patents pending in US, Canada, China, Taiwan and Mexico

Buy American Act Compliance:

RAB values USA manufacturing! Upon request, RAB may be able to manufacture this product to be compliant with the Buy American Act (BAA). Please contact customer service to request a quote for the product to be made BAA compliant.

Dimensions

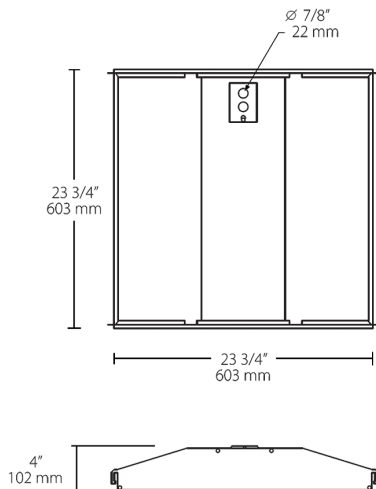

Features

- Ultra-efficient performance with DLC Premium listing
- Optional surface mount and drywall frame kits available
- 0-10V dimming, standard on all models
- 100,000-hour LED lifespan
- 5-Year, No-Compromise Fixture Warranty and 10-Year, No-Compromise Lightcloud Warranty
- Easy setup - simply power on, confirm device connectivity and call 844-LIGHTCLOUD

Ordering Matrix

Family	Size		Wattage	Color Temp	Driver	Options	Chicago Plenum
SWISH	2X2	-	29	N	/D10	/LC	
	2X4 = 2' x 4' 2X2 = 2' x 2'		19 = 19W (2x2) 29 = 29W (2x2) 39 = 39W (2x4) 49 = 49W (2x4)	Blank = 5000K Cool N = 4000K Neutral YN = 3500K Warm Neutral Y = 3000K Warm	/D10 = 0-10V Dimming	Blank = No Option /E2 = Battery Backup /LC = Lightcloud® Controller /LC/E2 = Lightcloud® Controller w/ Battery Backup /MVS = Microwave Occupancy Sensor /MVS/E2 = Microwave Occupancy Sensor w/ Battery Backup	Blank = Standard /CP = Chicago Plenum