



Technical Specifications (continued)

Other

Warranty:

RAB warrants that our LED products will be free from defects in materials and workmanship for a period of five (5) years from the date of delivery to the end user, including coverage of light output, color stability, driver performance and fixture finish. RAB's warranty is subject to all terms and conditions found at [rablighting.com/warranty](http://rablighting.com/warranty).

Patents:

This design is protected by patents pending in US, Canada, China, Taiwan and Mexico

Buy American Act Compliance:

RAB values USA manufacturing! Upon request, RAB may be able to manufacture this product to be compliant with the Buy American Act (BAA). Please contact customer service to request a quote for the product to be made BAA compliant.

Dimensions

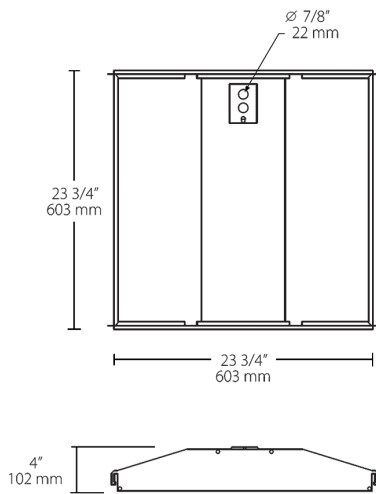

Features

- Ultra-efficient performance with DLC Premium listing
- Optional surface mount and drywall frame kits available
- Optional programmable occupancy sensor for multi-level lighting control
- 0-10V dimming, standard on all models
- 100,000-hour LED lifespan 5-Year, No-Compromise Warranty

Ordering Matrix

Family	Size	Wattage	Color Temp	Driver	Options	Chicago Penum
SWISH	2X2	-	29	N	/D10	/CP
	2X4 = 2' x 4' 2X2 = 2' x 2'	19 = 19W (2x2) 29 = 29W (2x2) 39 = 39W (2x4) 49 = 49W (2x4)	Blank = 5000K Cool N = 4000K Neutral YN = 3500K Warm Neutral Y = 3000K Warm	/D10 = 0-10V Dimming	Blank = No Option /E2 = Battery Backup /LC = Lightcloud® Controller /LC/E2 = Lightcloud® Controller w/ Battery Backup /MVS = Microwave Occupancy Sensor /MVS/E2 = Microwave Occupancy Sensor w/ Battery Backup	Blank = Standard /CP = Chicago Plenum

