

Technical Specifications (continued)**Performance****Lifespan:**

100,000-Hour LED lifespan based on IES LM-80 results and TM-21 calculations

Sensor Specifications**Capacitance Load:**

400VA at 120VAC, 800VA at 230VAC, 1000VA at 277VAC

Operating Temperature:

-20°C to +60°C (-4°F to +140°F)

Relay:

Zero-cross relay

Maximum Mounting Height:

16.4 feet

Customizable Detection Area:

10, 50, 75 or 100%

Time Delay:

5s, 30s, 1min, 5min, 10min, 20min, 30min

Cut Off Period:

0s, 10s, 1min, 5min, 10min, 30min, 1hr, Bi-Level

Cut-Off Dimming level:

10, 20, 30, 50%

Cut-Off Power:

Less than 1W

Daylight Threshold:

About .2-5 fc for disabled

Sensor Principle:

High Frequency

Microwave Frequency:

5.8GHz +/- 75MHz

Microwave Power:

<0.2mW

Max Detection Range:

26 ft diameter at 16 ft mounting height

Detection Angle:

About 30 to 150 degrees

Remote Control Accessory:

Adjust settings using remote control (catalog# MVSREM). Only available with 0-10V dimming driver options. [Remote control available here.](#)

Other**Warranty:**

RAB warrants that our LED products will be free from defects in materials and workmanship for a period of five (5) years from the date of delivery to the end user, including coverage of light output, color stability, driver performance and fixture finish. RAB's warranty is subject to all terms and conditions found at rablighting.com/warranty.

Patents:

This design is protected by patents pending in US, Canada, China, Taiwan and Mexico

Buy American Act Compliance:

RAB values USA manufacturing! Upon request, RAB may be able to manufacture this product to be compliant with the Buy American Act (BAA). Please contact customer service to request a quote for the product to be made BAA compliant.

Dimensions

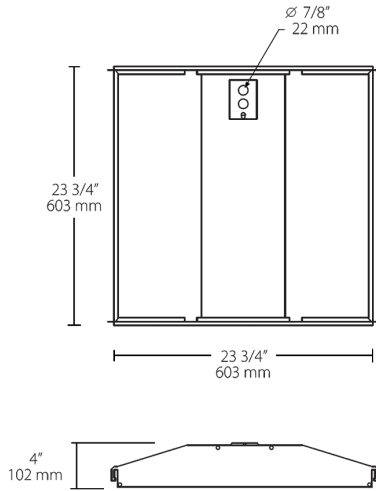

Features

- Emergency battery back-up included
- Optional surface mount and dry wall frame kits available
- Optional programmable occupancy sensor for multi-level lighting control
- 0-10V dimming, standard on all models
- 100,000-hour LED lifespan
- 5-Year, No-Compromise Warranty

Ordering Matrix

Family	Size		Wattage	Color Temp	Driver	Options	Chicago Plenum
SWISH	2X2	-	19	YN	/D10	/MVS/E2	
	2X4 = 2' x 4' 2X2 = 2' x 2'		19 = 19W (2x2) 29 = 29W (2x2) 39 = 39W (2x4) 49 = 49W (2x4)	Blank = 5000K Cool N = 4000K Neutral YN = 3500K Warm Neutral Y = 3000K Warm	/D10 = 0-10V Dimming	Blank = No Option /E2 = Battery Backup /LC = Lightcloud® Controller /LC/E2 = Lightcloud® Controller w/ Battery Backup /MVS = Microwave Occupancy Sensor /MVS/E2 = Microwave Occupancy Sensor w/ Battery Backup	Blank = Standard /CP = Chicago Plenum