

<b>Project:</b>	<b>Type:</b>
<b>Prepared By:</b>	<b>Date:</b>

Driver Info		LED Info	
Type	Constant Current	Watts	13W
120V	0.12A	Color Temp	2700K/3000K/3500K/4000K/5000K
208V	N/A	Color Accuracy	90 CRI
240V	N/A	L70 Lifespan	50,000 Hours
277V	N/A	Lumens	1,050 lm
Input Watts	13W	Efficacy	80.8

## Technical Specifications

### Performance

#### Description:

The SUMO offers a sleek, low-profile design that adds a modern look to any space. They are easy to install with field adjustable color temperature, affordable, and a stylish options for new construction or retrofit. Mounting kit for recessed housing sold separately.

#### Product Type:

Surface & Flush Mounts

#### Input Wattage:

13W

#### Lumens (Nominal):

1,050lm

#### Efficacy:

80.8lm/W

#### L70 Lifespan:

50,000-Hour LED lifespan based on IES LM-70 results

### Compliance

#### UL Listed:

Suitable for wet locations

#### Energy Star Approved:

ENERGY STAR® Version 2.2 Certified

#### Energy Star ID:

2389548

#### Trade Agreements Act Compliant:

This product is a product of Cambodia and a "designated country" end product that complies with the Trade Agreements Act

### Electrical

#### Dimming Driver:

TRIAC compatible dimmer with dimming as low as 10%.

#### THD:

≤20%

#### Power Factor:

≥0.9

#### Flicker:

≤30%

#### Input Voltage:

120V

#### Operating Frequency:

60Hz

### Construction

#### Material:

Plastic

#### Trim Style:

Smooth Trim

#### Shape:

Round

#### Mounting:

Surface and recessed mount

#### Operating Temperature:

-20°C (-4°F) to 40°C (104°F)

#### Size:

7"

### Optical

#### Beam Angle:

110°

### LED Characteristics

#### R9 Value:

High color performance with R9 greater than or equal to 50

**Technical Specifications (continued)**

**Other**

**Warranty:**

RAB warrants that our LED products will be free from defects in materials and workmanship for a period of five (5) years from the date of delivery to the end user, including coverage of light output, color stability, driver performance and fixture finish. RAB's warranty is subject to all terms and conditions found at [rablighting.com/warranty](http://rablighting.com/warranty).

**Buy American Act Compliance:**

RAB values USA manufacturing! Upon request, RAB may be able to manufacture this product to be compliant with the Buy American Act (BAA). Please contact customer service to request a quote for the product to be made BAA compliant.

**Dimensions**

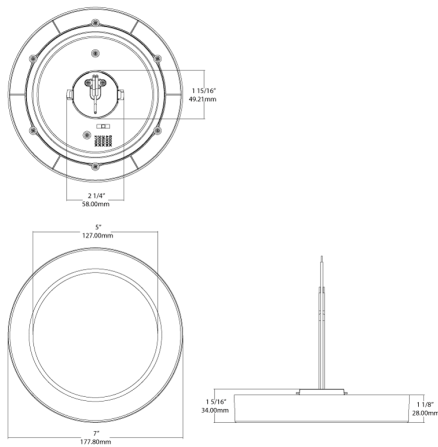

**Features**

- Surface or Recessed mounting options
- Select from 5 field-adjustable color temperatures 2700K, 3000K, 3500K, 4000K, or 5000K
- Suitable for wet and damp locations
- Dims down to 10% on compatible TRIAC/ELV dimming systems, see Dimmer Compatibility List
- Meets California Title 24 requirements

**Ordering Matrix**

Family	Size	Shape	Wattage	Color Temp	Voltage	Finish
SUMOFA	7	R	13	9CCT	120	W
	7 = 7" 9 = 9"	R = Round	12 = 12W 16 = 16W	95CCT = 90 CRI, 2700/3000/3500/4000/5000K CCT Adjustable	UNV = 120-277V, 0-10V Dimming UNVT = 120-277V, TRIAC Dimming	W = White