



<b>Project:</b>	<b>Type:</b>
<b>Prepared By:</b>	<b>Date:</b>

Driver Info		LED Info	
Type	Constant Current	Watts	38W
120V	N/A	Color Temp	3000K/4000K/5000K
208V	N/A	Color	90 CRI
240V	N/A	Accuracy	
277V	N/A	L70 Lifespan	15,000 Hours
Input Watts	38W	Lumens	3,600 lm
		Efficacy	95

**Technical Specifications**

**Compliance**

**UL Listed:**

Suitable for wet locations

**Electrical**

**Voltage:**

120V AC 60Hz

**Power Consumption:**

1W

**Surge Protection:**

Withstands up to 6000 volts

**Switching Capacity:**

120W Electronic Ballast (LED) @ 120 Volts

**Wall Switch Manual Override:**

Two flip logic prevents activation by momentary power outages. Stays on for 6 hours. No extra wiring needed.

**Construction**

**Temperature Compensation:**

Sensitivity adjusts automatically for consistent detection in hot and cold ambient temperatures

**Horizontal Lock, No-tool Joints:**

Keeps sensing pattern level for fast, error-free installation

**Floodlights:**

Precision die cast aluminum. 1/2" NPS threaded arm with serrated locking swivel fits all standard mounting boxes and covers.

**Lamps Supplied:**

Two (2) Edison base PAR38 lamps with three field-selectable color temperatures (3000/4000/5000K).

**LED Characteristics**

**LED Detection Indicator:**

Shows when sensor is detecting in daytime and glows red at night for "on-guard" deterrence

**Sensor Specifications**

**Advanced Detection Logic:**

Minimizes false triggers

**RF Immunity:**

Circuits fully shielded for maximum radio frequency immunity

**Auto Test Logic:**

5 minutes of test time when powered. Resets to auto mode without adjustment.

**Time Adjustment:**

5 seconds to 12 minutes

**Photoelectric Control:**

Deactivates lights during daylight. Fully adjustable for 24 hour operation or custom applications.

**Detection:**

200° view

**Wide Sensitivity Control:**

Adjustable from 100% to 30%

**Adjustable Detection Zone:**

Customize the protection pattern with included snap-on blinders (if required)

**Other**

**10 Yr Limited Warranty:**

The RAB 10-year, limited warranty covers light output, driver performance and paint finish. RAB's warranty is subject to all terms and conditions found at [rablighting.com/warranty](http://rablighting.com/warranty).

**Lamp Warranty:**

RAB warrants that our LED products will be free from defects in materials and workmanship for a period of three (3) years from the date of delivery to the end user, including coverage of light output, color stability, driver performance and fixture finish. RAB's warranty is subject to all terms and conditions found at [rablighting.com/warranty](http://rablighting.com/warranty).

**Technical Specifications (continued)**

**Buy American Act Compliance:**

RAB values USA manufacturing! Upon request, RAB may be able to manufacture this product to be compliant with the Buy American Act (BAA). Please contact customer service to request a quote for the product to be made BAA compliant.

**Dimensions**

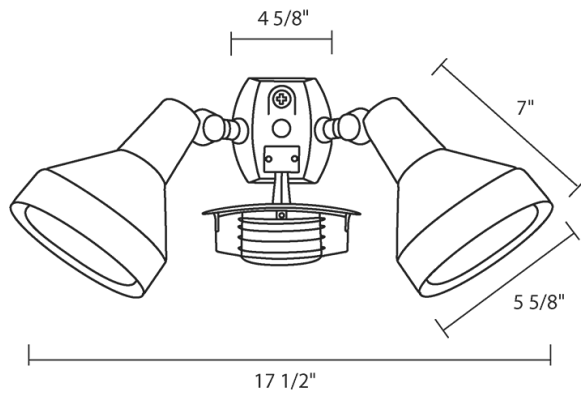

**Features**

- Two CCT-Selectable PAR38s
- 110° view sensor
- EZ Plate Universal Cover fits all outdoor boxes
- Protected Manual Override

**Ordering Matrix**

Family	Detection	Flood Type	Finish	Lamps/Wattages/CCT
STL	200	H	W	/L
	110 = 110° View 200 = 200° View 360 = 180° & 360° Down for Total Detection	H = Bullet Hoods	Blank = Bronze W = White	/L = 2-Edison Base PAR38 Lamps, 38W, Selectable CCT: 3000/4000/5000K