

SMSLES2X13

INSTALLATION MANUAL



Easy Answers

RAB[®]
© 2019 RAB LIGHTING Inc.
Northvale, New Jersey 07647 USA

rablighting.com
Visit our website for product info

Tech Help Line
Call our experts: 888 722-1000

Free Lighting Layouts
Answered online or by request

e-mail
Answered promptly - sales@rablighting.com

RAB[®]

INSTRUCTIONS

SMSLES2X13 INSTALLATION



RAB Lighting is committed to creating high-quality, affordable, well-designed and energy-efficient LED lighting and controls that make it easy for electricians to install and end users to save energy. We'd love to hear your comments. Please call the Marketing Department at 888-RAB-1000 or email: marketing@rablighting.com

IMPORTANT

READ CAREFULLY BEFORE INSTALLING FIXTURE. RETAIN THESE INSTRUCTIONS FOR FUTURE REFERENCE.

RAB fixtures must be wired in accordance with the National Electrical Code and all applicable local codes. Proper grounding is required for safety. THIS PRODUCT MUST BE INSTALLED IN ACCORDANCE WITH THE APPLICABLE INSTALLATION CODE BY A PERSON FAMILIAR WITH THE CONSTRUCTION AND OPERATION OF THE PRODUCT AND THE HAZARDS INVOLVED.

WARNING: Make certain power is OFF before installing or maintaining fixture. No user serviceable parts inside.

CAUTION: For proper weatherproof function all gaskets must be seated properly and all screws inserted and tightened firmly. Apply weatherproof silicone sealant around the edge of the ceiling mounting box and/or junction box. This is especially important with an uneven ceiling surface. Silicone all plugs and unused conduit entries.

WHY RAB SENSORS?

Smaller is better!

Mini Sensor uses state-of-the-art surface mount technology (SMT), just like cellular phones and beepers. SMT gives you more reliability, greater RF immunity, and a compact sensor that can fit neatly where others cannot.

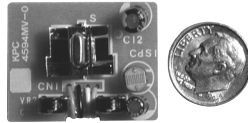

Wider is better!

The wide 180° view detects movement along the entire side of a building with only one compact sensor. It will detect people as they exit or enter. It takes several conventional sensors to get the same coverage.

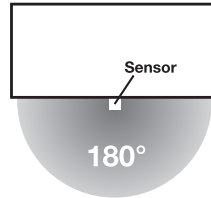

Molded is better!

No leaky gaskets or bug hotels with Mini Sensor. The hard lens is molded as part of the case. It's vandalproof, rainproof, bugproof and absolutely sealed.



INSTRUCTIONS

SMSLES2X13 INSTALLATION



RAB Lighting is committed to creating high-quality, affordable, well-designed and energy-efficient LED lighting and controls that make it easy for electricians to install and end users to save energy. We'd love to hear your comments. Please call the Marketing Department at 888-RAB-1000 or email: marketing@rablighting.com

CONTENTS



SMSLES2X13

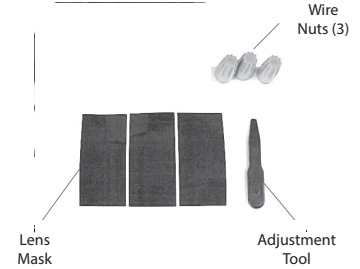

SENSOR SPECIFICATIONS

Model: 500 Watts Incandescent
100 Watts Fluorescent at 120 Volts
500W LED SMSLES13 at 120 Volts
5 Amps, 450 Watts LED at 120 Volts with 0.8pF driver
5 Amps, 300 Watts LED at 120 Volts with 0.5pF driver

Voltage: 120 Volts AC

Power Consumption: 1W

UL Listing: Raintight Photoelectric Switch
Suitable for wet locations.

Time Adjustment: 5 seconds to 15 minutes

Quick Test Time: 5 second test time for fast installation. Works day or night.

Detection Zone: Full 180° by 30'

"No Hands" Auto Testing: Auto mode starts after 3 minutes of testing.
No adjustment needed.

Built for Severe Conditions: Double weatherproofing for long life.

Photoelectric Control: Deactivates lights during daylight. Fully adjustable for 24 hour operation or custom applications.

Vandal Resistant Lens: Hard lens resists casual vandalism.

Case Construction: Precision molded Lexan®

Color Matched Lens: Dark lens with black units. White lens with white units.

Surge Protection: Withstands up to 3000 Volts

Manual Override: Double flip wall switch logic prevents activation by short power outages. Resets to auto at dawn.
No extra wiring needed.

LED Detection Indicator: Glows red day and night for "on-guard" deterrence.

RF Immunity: Circuits fully shielded for maximum radio frequency immunity.

ASSEMBLY AND WIRING

TURN OFF POWER BY REMOVING POWER FUSE OR TURNING OFF CIRCUIT BREAKER BEFORE INSTALLATION.

- Total lighting load must not exceed:
500W LED SMSLES13 at 120 Volts
5 Amps, 450 Watts LED at 120 Volts with 0.8pF driver
5 Amps, 300 Watts LED at 120 Volts with 0.5pF driver.
To switch more wattage, an electrician can install an additional relay.
- Line Carrier Remote Control Systems such as X-10, Leviton or Radio Shack are incompatible with sensors and cause false activations.
- Do not install on circuits feeding motor loads such as kitchen appliances, HVAC equipment, washer/ dryer or garage door openers.
- Sensor functions best when movement is across its detection pattern, not towards the sensor.
- Mount 6'-10' high for optimum range and direction. (fig. 1.)

Fig: 1

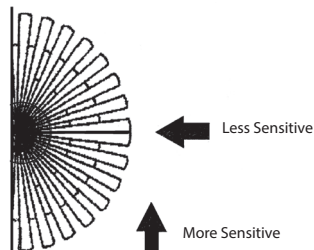

Two SMSLES13 heads come pre-wired and assembled along with SMS500 sensor on CU4 plate, allowing for mounting on round, rectangular or octagonal surface or recessed boxes.

1. Connect the black fixture lead to the (+) LINE supply lead. (fig. 2.)
2. Connect the white fixture lead to the (-) COMMON supply lead.
3. Connect the GROUND wire from fixture to supply ground.
4. Red pigtail is only used to switch remote or additional fixtures.

Fig: 2

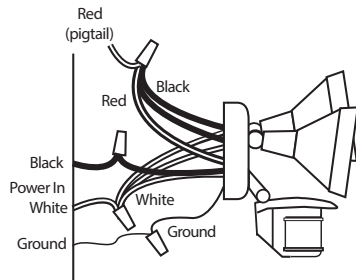

FIXTURE MOUNTING

Two LESLIE13 heads come pre-wired and assembled on CU4 plate, allowing for mounting on round, rectangular or octagonal surface or recessed junction boxes. Apply weatherproof silicone sealant around the edge of the **Junction Box** (not supplied). This is especially important with an uneven wall surface.

1. Attach the **Universal Mounting Bar** with the screws provided to the **Junction Box** (fig. 3.) In case of surface mount junction box, use with the **Metal Surface Plate**.
2. Use the 'S' shaped hands free **Hanging Hook** to hold the **CU4 plate** during wiring.
3. Bring power leads and **LESLIE13** head leads into **Junction Box**.
4. Strip off at least 1/2" of insulation from all leads, and insert through openings in **Metal Surface Plate** (if used).
5. Attach ground wire to grounding screw on **Junction Box**. Complete wiring as shown in wiring diagram section.
6. Align **Gasket**, **CU4 Plate** and **Metal Surface Plate** (for use with surface mounted junction boxes) to ensure proper seal.
7. Tighten **Center Screw** (make sure **O-Ring Gasket** is on the screw) to attach **CU4 plate** to the box. Check that the **Gasket** is fully sealed.
8. Insert plastic **Finishing Cap** in the center of the **CU4 plate** for a weatherproof seal. Use silicone sealant on all plugs and unused conduit entries.
9. Aim LESLIE13 heads in the desired direction and tighten locknut and arm screw.

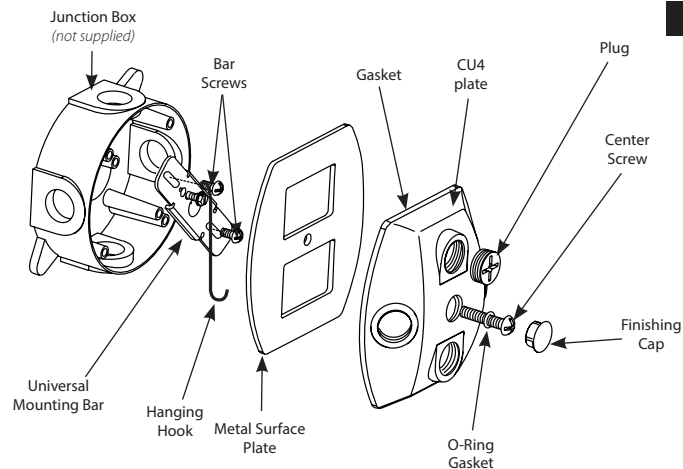
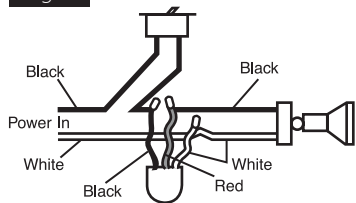

Fig: 3

SETTINGS

To override sensor with a manual switch (fig. 4.)

Fig: 4



To switch more than rated load (fig. 5.)

Fig: 5

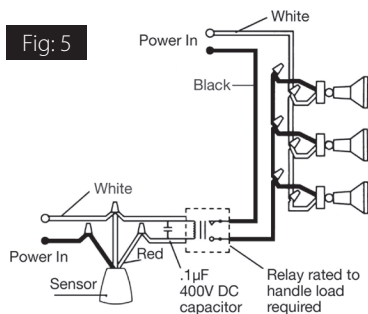

Multiple sensors

Wiring more than one sensor together is recommended only for the experienced installer because it becomes difficult to troubleshoot. Single sensors that control their own lights pinpoint movement more accurately and operate better.

Power Quality

Sensors should not be installed on a circuit that also feeds motor loads such as HVAC equipment, kitchen appliances, or garage door openers. If voltage varies significantly from 120 volts, sensors may malfunction.

The Mini Sensor infrared sensor “sees” small temperature changes caused by the motion of people or cars within its detection zone and turns on lights automatically. It welcomes visitors and may deter intruders.

How long do the lights stay on?

Lights remain on as long as there is movement within the Detection Zone. Once the zone is vacated, lights can be adjusted to remain on approximately 5 seconds up to 15 minutes.

Will the sensor detect animals?

Mini Sensor may detect large animals. Having animals trigger the sensor can give property a “lived-in” look. You can limit animal detection by placing opaque weatherproof tape on the lower part of the lens or using the bottom mask on the Lens Mask Kit provided. (fig. 6.)

Fig: 6

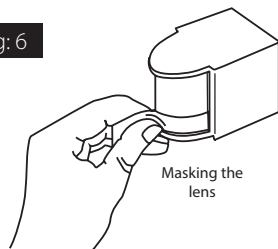

What does Manual Override do?

Keep lights on by flipping the wall switch two times within 5 seconds. Sensor resets to auto mode at dawn. No extra wiring needed.

How are the Time, Sensitivity and Photocell adjusted?

TimeControl: Sets the time that lights will remain on after the Detection Zone is vacated from approximately 5 seconds to 15 minutes. Use the adjustment tool

SETTINGS

provided to turn clockwise to increase the time. (fig. 7)

Factory Setting: 5-8 minutes.

Photocell Control: For night only operation, use the tool provided or a small screwdriver to turn the Photocell Control (fig. 7) all the way counter-clockwise (to the moon symbol). For operation in low level lights, turn the knob all the way clockwise (to the sun symbol). Adjust counterclockwise to have the sensor come on later at dusk, clockwise to have it come on earlier. Turning photocell control will show when the sensor “thinks” the current ambient light level = night, because the lights will turn on.

Factory setting : Night Only

Sensitivity: Increases or decreases the responsiveness and range of the sensor.

Control Panel

Turn controls gently using adjustment tool provided. Do not force past stops. (fig. 7)

Fig: 7

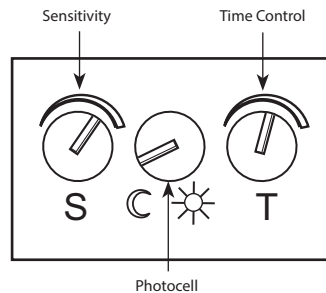

PICKING A LOCATION

Location Considerations

1. Choose a location from which the sensor can “see” all the paths of movement that will be illuminated by its lights.
2. Mini Sensor may be wall or ceiling mounted.
3. Sensor functions best when the direction of expected movement is across its detection pattern, not towards the sensor.
4. If wall mounting, locate 6-10' high for optimum range and detection. Lower mounting height will reduce range. Sensor must be below and as far as possible away from lights. If ceiling mounted be sure there are no lights below sensor.

DETECTION PATTERN

1. The sensor has a “Double Look Down” Lens with one “Look Out” zone and two “Look Down” zones, for excellent detection both at long and close range
2. Detection extends out a maximum of 30 feet and is 180° wide.
3. To reduce the Detection Pattern length, aim the sensor down
4. To reduce Detection Pattern width, mask the sides of the lens with the Lens Mask Kit provided or opaque weatherproof tape.
5. If sensor is mounted by a doorway at the top of stairs, be aware that the elevated mounting height may extend the sensors range.

DETECTION PATTERN (cont.)

- As distance from the sensor increases, it will take more movement to be detected. For instance, at 10 feet, a half step will be enough, while at 30 feet, several steps will be necessary.

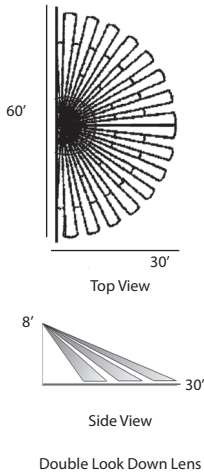

- If another 3 minute Test Period is desired, turn the power off for at least 10 seconds and back on again.

Walk Test

The purpose of the Walk Test is to check and adjust the coverage pattern.

- Aim the sensor approximately to cover the area you desire.
- Start outside the Detection Zone and walk across the zone until the lights go on. As distance from the sensor increases, it will take more movement to be detected. For instance, at 10 feet, a half step will be enough, while at 30 feet, several steps will be necessary.

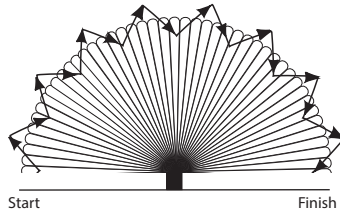

AIMING AND WALK TESTING

Test Period

The sensor has a 3 minute Test Period which allows it to be aimed and walk tested day or night.

- For the first 30 seconds, the lights will be turned on. During this time, test that all fixtures and lamps function properly.
- For the next 3 minutes, the sensor will keep lights on for 5 seconds each time it detects movement in its Detection Zone. The sensor will change to Automatic Mode after the 3 minute Test Period.

- To reduce range, use the lens masks provided or tilt sensor down. Repeat steps #2 and #3 until you are satisfied with the coverage.
- The Time Control is factory set between 5-8 minutes. This period starts after the movement in the Detection Zone ceases. If less time is desired, turn the time control counterclockwise. For more time, turn the control clockwise.

TECHNICAL TIPS

Lights Do Not Turn Off

- Make sure sensor is not aimed at something that would move or change temperature such as waving branches, water, air conditioners, windows or heating vents - even on neighboring property. You can test for infrared sources in the area by placing a box or bag over the sensor. Put sensor into Test Mode. After the initial 30 seconds of the lights being on, lights should stay off. Wave your hand inside the bag in front of sensor. Lights should go on and then time out. If sensor operates properly when covered, check items 2-6.

Problem: Sensor is triggered by unwanted movement or heat source.

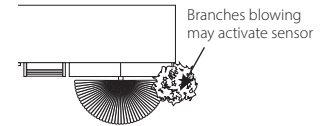

Solution: Tilt sensor (Pg.9) or mask lens in the direction of the source. Move sensor or source.

- Make sure sensor is mounted firmly and does not move even slightly when touched. If it moves, tighten all screws.
- Make sure that Mini Sensor is not mounted on an unstable object such as a tree or a pole that will move in the wind.
- Was sensor wired hot? If so, circuitry may have been damaged.
- Make sure sensor is not aimed within 30 feet of a road.

CONTROL PANEL

Turn controls gently using the adjustment tool provided. Do not force past stops.

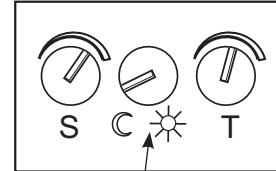

Photocell
Turn to moon symbol for night only

Turn to sun symbol for 24 hour operation (lights turn on night and day)



TECHNICAL TIPS

Problem: Passing cars activate sensor.

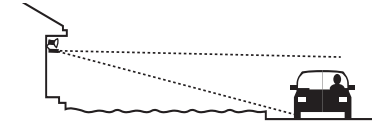

Solution: A 20' safety zone between the sensor and road is recommended to avoid activation from passing cars.

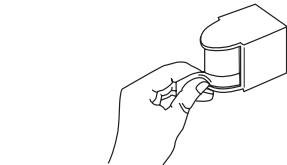
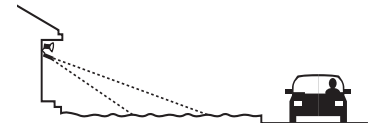

You may tilt sensor to not aim in the direction of the street or mask top of sensor lens to reduce range

Make sure heat from lights is not triggering sensor. Make sure the sensor is below and as far as possible away from lights.

Check that the sensor is level from side to side and pointed at the area you desire. If unit is tilted, part of the Detection Zone may be high in the air over people's heads.

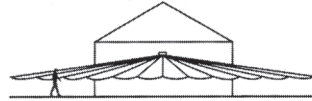

Solution: Position sensor exactly level from side to side.

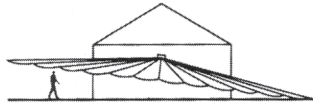

Check that the sensor is not mounted too high. If mounted above 20 feet, much of the usable range will be lost.

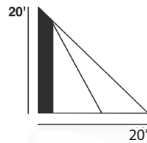

Solution: Mounting at 5' to 8' allows maximum range.

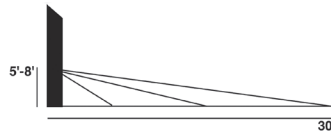

If sensor is painted, make sure there is no paint on the lens and that the lens paint mask is removed.

TECHNICAL TIPS

Range Appears Limited

1. Check that movement is not directly towards sensor. Sensor will see movement across its pattern more quickly. To fix, move the sensor.

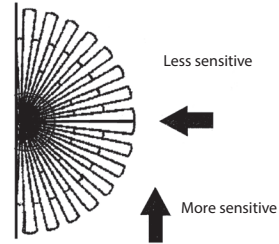

2. Check that movement far away and directly towards sensor is not entirely within one Detection Pattern finger.

Problem: Sensor will not detect until movement crosses from one finger into a second finger.

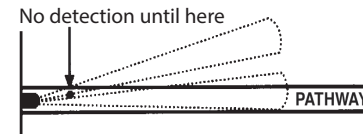

Solution: "Micro Adjust" sensor by tilting sensor 1/16". This small adjustment may move the zones to allow earlier detection.

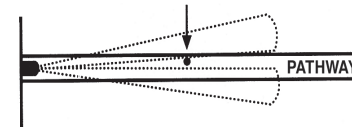

Lights Do Not Turn On

1. Check that lamps and fixtures work. Compare wiring to the Wiring Diagram in this manual. Check that the power is on.
2. If installing during daylight, remember that the sensor will provide a 3 minute Test Period after power is turned on. After 3 minutes, the sensor will switch to Automatic Mode and will not work during daylight if the Photocell Control is turned to or near the night only position (fully counter clockwise to the moon symbol).

If you require another 3 minute Test Period, turn the power off for at least 10 seconds and back on again.

If you require the sensor to operate both in low level light and at night, turn the Photocell Control knob clockwise to the sun symbol.

3. Check that lights from other sources, such as adjacent porch lights, garden lights, streetlights or lights from inside the house are not in the sensor's view. See #1 under "Lights Turn Off Too Quickly".

4. Was sensor wired hot? If so, circuitry may have been damaged.
5. If sensor is painted, make sure there is no paint on the lens and that the lens paint mask is removed.

TECHNICAL TIPS

Lights Turn Off Too Quickly

1. Check if sensor is being "tricked" by reflected light. If lights shine or reflect into the photocell, (located behind the lens), the unit will go on briefly and turn off thinking it is daytime.

Problem: Lights reflect into photocell or lights shine directly into photocell.

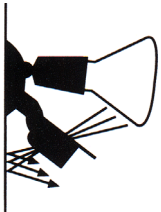

Solution: Adjust Photocell Control slightly clockwise, toward the sun symbol. This allows the sensor to function in brighter ambient light conditions. Alternatively, move the lights or mask the lens in the direction of the lights or reflections. If the problem persists, it may be necessary to increase the length of the sun shield over the sensor using weatherproof tape or some other material.

2. Check if "R" lamps, "A" lamps or self-ballasted PL lamps are being used in a non-enclosed lampholder that can be "seen" by the sensor. If so, switch to reflector PAR floodlight lamps or Quartz floods so the sensor is not affected by stray light. If using PAR floodlights, consider using lower wattage, energy saving lamps.

Self ballasted compact fluorescent lamps may cause the sensor to cycle on and off.

Lights Turn On and Off Incorrectly

1. Make sure the sensor is installed on its own dedicated circuit free of motor loads such as HVAC equipment, kitchen appliances or garage door openers.
2. It is not recommended to wire sensors in parallel. More than one sensor wired together makes them difficult to troubleshoot. Disconnect multiple sensors and test separately.
3. Keep all people completely out of the detection pattern to make sure the sensor is not detecting them.
4. Make sure sensor is located below and as far as possible from its lights. Heat from the lights may trigger the sensor.



Solution: Move sensor below and away from the lights.



TECHNICAL TIPS

5. Make sure lights are not visible from or reflecting back into sensor. Check for white or reflective surfaces close to the sensor.

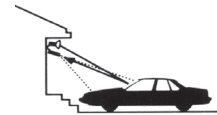

Solution: Aim sensor away from lights and reflective objects or mask the lens in the direction of the light or reflection.

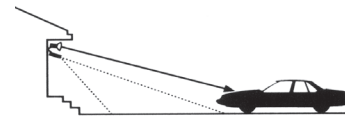

6. Heavy rain, snow or high winds may activate the sensor occasionally

Solution: Reduce sensitivity control settings, mount in a more protected area and/or mask the lens if this is a constant problem.

7. Make sure sensor is not aimed within 30' of a road or sidewalk. Passing cars will activate sensor.

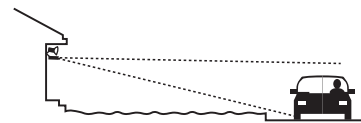

Solution: Mask the top of the lens to reduce Detection Pattern Length.

8. Self ballasted PL lamps may cause cycling (on-off).
9. Check solutions 1, 2, 3, 5 & 6 under "Lights Do Not Turn Off" (Pg. 10).

Lights Turn On For Unknown Reasons

1. Lights may turn on occasionally during rain, snow and windstorms because the sensor is detecting changes in temperature. If this is a constant problem, mount the sensor in a more protected area.
2. Tilt the sensor lower - it may be seeing distant objects moving.
3. You may not be aware that animals have triggered sensor. Check sensor aiming to reduce nuisance triggering or mask the lower part of the lens with opaque weatherproof tape.

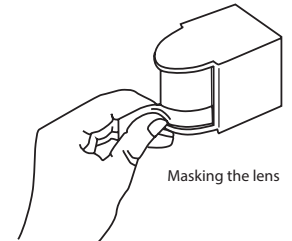

4. The sensor may turn on occasionally during voltage surges.
5. A possible source of "mysterious" sensor activations are strong local radio signals. Check for nearby CB, Ham, VHF radio transmitters or Cellular telephones. The sensor may be activated, but will not be permanently impaired by these signals.
6. Check other solutions mentioned under on pages 12 & 13.

RAB WARRANTIES

RAB Sensor Warranty

The SMARTBULLET RAB Sensor will be free from defects in materials and workmanship for a period of ten (10) years from the date of delivery to the end-user.

Sensors must be installed by a properly insured and licensed electrician or under the supervision of a licensed electrician and the product must be in its original, unopened and new condition at the time of installation. The information provided in the RAB Sensor Owner's Manual is critical in determining the location, conditions, intended use and other requirements with respect to the use and installation of a sensor product. Using a sensor product in any manner other than as disclosed in the RAB Owner's Manual automatically voids the warranty.

Exceptions. The above warranties shall not apply and RAB makes no representations or warranties with respect to:

- problems caused by acts of God including without limitation lightning strikes; and
- problems caused by any improper action or failure to act by any person or entity other RAB, including without limitation problems caused by improper installation by the buyer, an authorized RAB distributor, or any other person or entity; and
- using or installing a sensor product in any manner other than as disclosed in the RAB Owner's Manual.
- use with Instant Start ballasts; use with Instant Start ballasts will void the RAB warranty.

Out of warranty sensors replacement program.

If your sensor is out of warranty or if damage is unrelated to its original manufacture, return your sensor (freight prepaid and insured) directly to us (at RAB Lighting Inc. 170 Ludlow Ave. Northvale, NJ 07647) with a check for \$50.00 made payable to RAB Lighting Inc. We will repair or replace your sensor promptly.

RAB Product Warranties

The following warranties apply to RAB Lighting, Inc. ("RAB") products that meet all of the following conditions: (a) the product was purchased by the contractor or end-user from an authorized RAB distributor who purchased the product directly from RAB and from no other source; (b) if the product has been installed, the entire installation was performed by a licensed electrician or under the supervision of a licensed electrician and the product was in its original, unopened and new condition at the time of installation. RAB LIGHTING DISCLAIMS ALL REPRESENTATIONS AND WARRANTIES WITH RESPECT TO ALL OTHER PRODUCTS, INCLUDING WITHOUT LIMITATION PRODUCTS THAT HAVE BEEN PURCHASED FROM ANY PERSON OR ENTITY OTHER THAN AN AUTHORIZED RAB DISTRIBUTOR, OR INSTALLED BY ANY PERSON OR ENTITY OTHER THAN A LICENSED ELECTRICIAN OR UNDER THE SUPERVISION OF A LICENSED ELECTRICIAN, AND ALL PRODUCTS THAT ARE USED OR ARE OTHERWISE NOT IN THEIR ORIGINAL RAB LIGHTING PACKAGING AT THE TIME OF INSTALLATION.

Remedy. RAB's obligations for breach of warranty shall be limited to repair or replacement, at RAB's option, of any products or parts which prove to be defective, provided that buyer gives RAB written notice and returns the defective product to RAB in accordance with RAB's return material authorization (RMA) policies, and RAB confirms the defect. Buyer is responsible for all costs to de-install defective products and re-install replacement or repaired products and RAB shall not be liable for labor or other costs related to de-installation or re-installation.

DISCLAIMER. THE FOREGOING WARRANTIES ARE IN LIEU OF, AND RAB EXPRESSLY DISCLAIMS, ALL OTHER REPRESENTATIONS, GUARANTEES AND WARRANTIES, EXPRESS OR IMPLIED IN FACT OR

RAB WARRANTIES

BY LAW, INCLUDING WITHOUT LIMITATION ALL WARRANTIES OF MERCHANTABILITY OR FITNESS FOR A PARTICULAR PURPOSE OR OTHERWISE. THE FOREGOING WARRANTIES STATE RAB'S ENTIRE AND EXCLUSIVE LIABILITY, AND BUYER'S SOLE AND EXCLUSIVE REMEDY, IN CONNECTION WITH THE PRODUCTS AND ALL PARTS, THEIR DESIGN, SUITABILITY FOR USE, INSTALLATION AND OPERATION.

LIMITATION OF LIABILITY. RAB shall not be liable under any theory of relief, including without limitation breach of warranty, breach of contract, tort (including negligence), strict liability, or otherwise, arising out of or related to any breach of warranty, any RAB products and the use thereof, or any other acts or omissions of RAB for: (i) any indirect, incidental, special or consequential damages, whatsoever (including without limitation, loss of anticipated value of a business or its reputation) or (ii) any damage or loss in excess of the price actually paid by buyer to the authorized RAB distributor for the products that caused the damages. Any action by buyer must be commenced within one year after the cause of action has accrued.

Miscellaneous. These product warranty terms shall be governed by the laws of the State of New York. Buyer consents to the personal jurisdiction and venue of the courts of the State of New York. Any legal or equitable claim of any nature arising hereunder shall be filed and maintained in the state or federal courts in the State of New York and buyer agrees that such courts are a convenient forum for adjudication. In the event that suit is necessary to recover amounts owed RAB, buyer shall be liable for reasonable attorney's fees, interest and costs of collection. No agreement or understanding varying the terms and conditions hereof shall be binding upon RAB or buyer unless in writing and signed by duly authorized representatives of both parties. These product warranty terms shall inure to the benefit of and be binding upon the parties hereto and their respective successors and assigns.

TOLL FREE TECHNICAL ASSISTANCE

If you need technical assistance, please do the following:

1. Re-read the Technical Tips sections of this manual.
2. Call the Tech Help Line at **888 RAB-1000**, 8AM to 6PM Eastern Time M-F and we will be glad to help you. Before you call, please have the following information handy
 - a) Catalog number of your unit;
 - b) Wattage, types and locations of lights connected to the sensor;
 - c) The electrical circuit on which the sensor is installed. What else does it feed? How is the sensor power switched?
 - d) Serial Number (4 digits) on the back of the sensor.
 - e) This installation Manual:

RAB Lighting cannot give electrical wiring instructions by phone. Please consult a qualified electrician

Note: *These instructions do not cover all details or variations in equipment nor do they provide for every possible situation during installation operation or maintenance.*