

INSTRUCTIONS

7" Edge-Lit Surface Mount



RAB Lighting is committed to creating high-quality, affordable, well-designed and energy-efficient LED lighting and controls that make it easy for electricians to install and end users to save energy. We'd love to hear your comments. Please call the Marketing Department at 888-RAB-1000 or email: marketing@rablighting.com

SM7R159XXUNT VW



SM7S159XXUNT VW

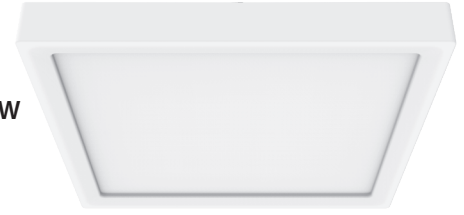

IMPORTANT

READ CAREFULLY BEFORE INSTALLING FIXTURE. RETAIN THESE INSTRUCTIONS FOR FUTURE REFERENCE.

RAB fixture must be wired in accordance with the National Electrical Code and all applicable local codes. Proper grounding is required for safety. THIS PRODUCT MUST BE INSTALLED IN ACCORDANCE WITH THE APPLICABLE INSTALLATION CODE BY A PERSON FAMILIAR WITH THE CONSTRUCTION AND OPERATION OF THE PRODUCT AND THE HAZARDS INVOLVED.

TO PREVENT ELECTRICAL SHOCK, POWER SHOULD BE TURNED OFF AT THE FUSE BOX BEFORE INSTALLATION.

SAFETY WARNINGS:

Read all product labels and directions.

- **WARNING – Risk of fire or electric shock.** LED Retrofit Kit installation requires knowledge of luminaires electrical systems. If not qualified, do not attempt installation. Contact a qualified electrician.
- **WARNING – Risk of fire or electric shock.** Install this kit only in the luminaires that have the construction features and dimensions shown in the photographs and/or drawings and where the input rating of the retrofit kit does not exceed the input rating of the luminaire.
- Installation should be performed only by a qualified electrician in accordance with the National Electrical Code and relevant local codes. Do not make or alter any open holes in an enclosure of wiring or electrical components during kit installation.
- **WARNING – To prevent wiring damage or abrasion, do not expose wiring to edges of sheet metal or other sharp objects.**
- Replace only with RAB Lighting Inc. Visit our website: RABLIGHTING.COM Call our experts at 888 722-1000
MODEL# SM7R158XX120W SM7R159XXUNVTW SM7R159XXUNVW SM7S158XX120W SM7S159XXUNVTW SM7S159XXUNVW
- The recessed luminaire is intended for mounting only in a covered ceiling where only the led side of the luminaire will be exposed to damp or dry or wet locations.
- **INSTALLATION SHOULD ONLY BE PERFORMED AFTER POWER TO THE FIXTURE HAS BEEN DISCONNECTED.**
- These instructions shall be included on an information sheet packaged with each unit.
- The enclosed device complies with Part 15 of the FCC Rules. Operation is subject to the following two conditions: (1) this device may not cause harmful interference, and (2) this device must accept any interference received, including interference that may cause undesired operation.

WHAT'S IN THE BOX



Fixture (1)



Screws (2)

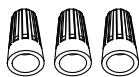

Nuts (3)



Lumi Sticker (1)

OPTIONAL ACCESSORIES

Our fixture is compatible with most common 5" and 6" recessed housings, please purchase the LAMPSOCKET E26 SET (Model# SM7/ACC - including E26 adapter, female connector, torsion springs and screws) for installation in housings.



E26 adapter (1)



Female connector (1)



Torsion Springs (2)



Screws for torsion springs (2)

TOOLS NEEDED

Installation with J-BOX

A screwdriver is needed for installation.

Installation with Existing Housing

No tools are necessary for installation.

MIN. LAMP COMPARTMENT DIMENSIONS

Installation with J-BOX

J-box Min Volume - 18 in³, Min Length: 3.5in, Height: 2.19in

Compatible with standard J-box

Installation with Existing Housing

Min lamp compartment dimensions - Dia: 5.51in, Height: 7.09in.

Compatible with most common types for 5/6" Recessed housings

DIMENSIONAL DRAWINGS

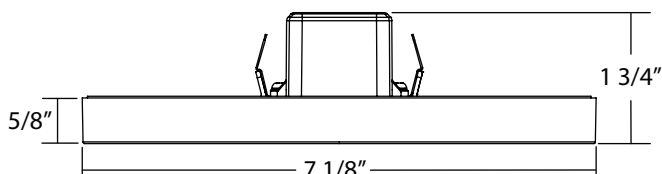

INSTRUCTIONS

7" Edge-Lit Surface Mount



RAB Lighting is committed to creating high-quality, affordable, well-designed and energy-efficient LED lighting and controls that make it easy for electricians to install and end users to save energy. We'd love to hear your comments. Please call the Marketing Department at 888-RAB-1000 or email: marketing@rablighting.com

INSTALLATION WITH J-BOX

1. Make sure the POWER IS TURNED OFF at the source to the J-box in which you are installing the product.
2. Squeeze the clips and take out bracket from fixture. (Fig.1)

Fig: 1

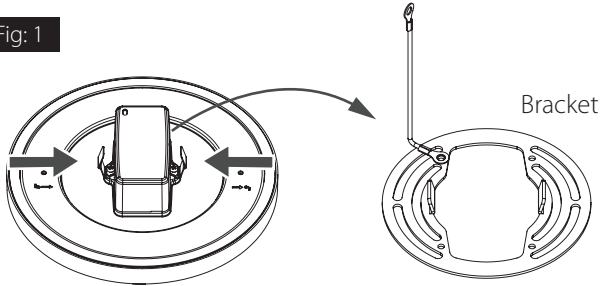

3. Connect the Ground Wire (green) to J-box, and fasten the bracket to J-box with the screws provided in package. (Fig.2) Pay attention to the direction of bracket.

Fig: 2

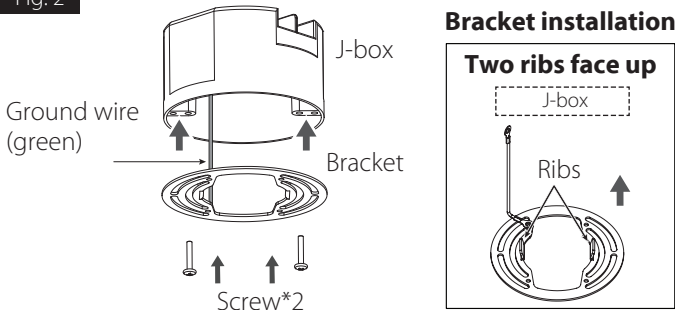

4. Connect the wires of J-box to fixture, white - white, black - black. (Fig.3)

Fig: 3

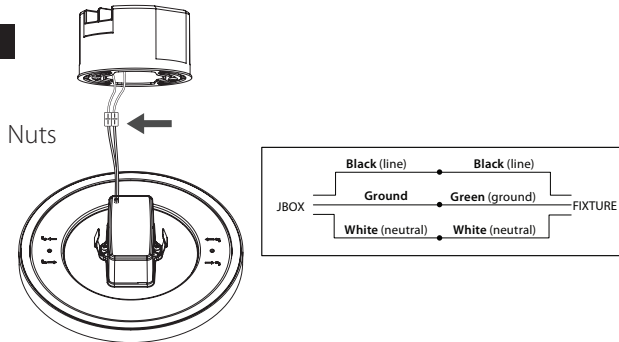

5. Push fixture up into the mounting bracket until it clicks into place (Fig.4).

Fig: 4

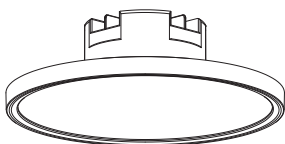

INSTALLATION WITH EXISTING HOUSING

1. Squeeze the clips and remove the bracket from friction, the bracket is no need for installation with existing housing. (Fig.5)

Fig: 5

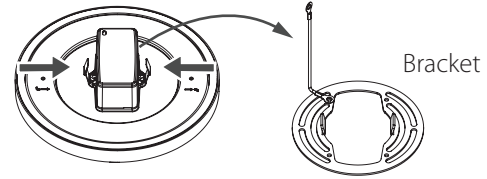

2. Wire the fixture with female connector. (Fig.6) Insert the black wire into the side marked (+) and the white wire into the side marked (-). Make sure both wires are tightly secured.

Fig: 6

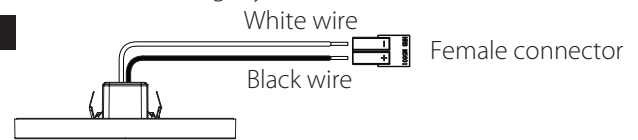

3. Install the torsion springs on the back of the fixture. Fix the torsion springs on the lamp body and the direction of 5 inch and 6 inch can be selected. Make sure the screws for torsion springs are tightened. (Fig. 7)

Fig: 7

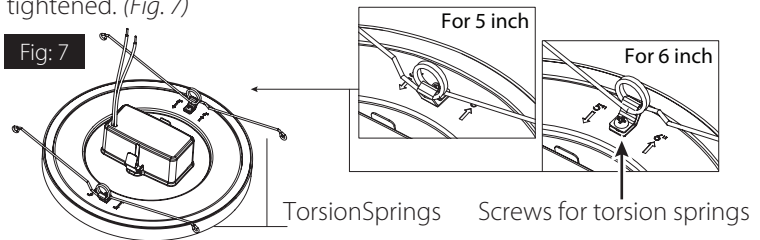

4. Screw the E26 adapter into the socket. Then connect male connector of E26 adapter to the female connector of the fixture. (Fig. 8)

Fig: 8

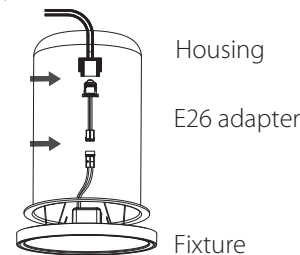

5. Squeeze torsion springs as shown and install into the metal brackets inside the recessed housing. (Fig.9) Carefully place wires into fixture and push the LED trim into the housing until flush with ceiling. (Fig.10)

Fig: 9

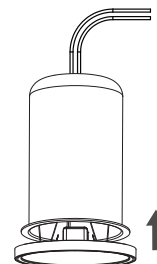

Fig: 10



Note: These instructions do not cover all details or variations in equipment nor do they provide for every possible situation during installation, operation or maintenance.



Easy Answers

rablighting.com
Visit our website for product info

Tech Help Line
Call our experts: 888 722-1000

e-mail
Answered promptly - sales@rablighting.com

Free Lighting Layouts
Answered online or by request