



## Technical Specifications (continued)

### Electrical

#### Driver:

Constant Current, Class 2, 120-277V, 50/60 Hz, 120V:  
0.16A, 208V: 0.10A, 240V: 0.09A, 277V: 0.08A

#### THD:

3.61% at 120V, 6.33% at 277V

#### Power Factor:

99.3% at 120V, 88.6% at 277V

#### Surge Protection:

4kV

### Performance

#### Lifespan:

100,000-Hour LED lifespan based on IES LM-80  
results and TM-21 calculations

### Other

#### Warranty:

RAB warrants that our LED products will be free from defects in materials and workmanship for a period of five (5) years from the date of delivery to the end user, including coverage of light output, color stability, driver performance and fixture finish. RAB's warranty is subject to all terms and conditions found at [rablighting.com/warranty](http://rablighting.com/warranty).

#### Buy American Act Compliance:

RAB values USA manufacturing! Upon request, RAB may be able to manufacture this product to be compliant with the Buy American Act (BAA). Please contact customer service to request a quote for the product to be made BAA compliant.

## Dimensions

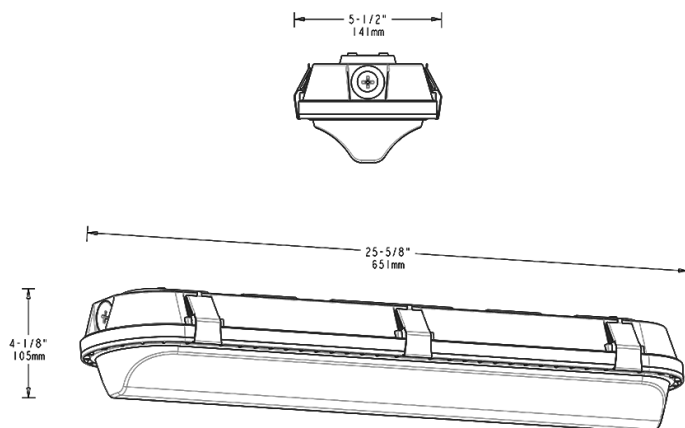

## Features

- UL Marine Listed
- Impact-resistant linear washdown
- Ideal for tunnels and stairwells
- Mounting options: Chain, junction box, angled surface mount or vandal-resistant surface mount
- IP66 Rating protects against dust & water ingress
- 5-Year, No-Compromise Warranty
- 100,000-Hour LED lifespan