



Color: Silver trim

Weight: 2.9 lbs

**Project:**

**Type:**

**Prepared By:**

**Date:**

### Driver Info

Type	Constant Current
120V	0.08A
208V	N/A
240V	N/A
277V	N/A
Input Watts	8.8W

### LED Info

Watts	8W
Color Temp	3000K (Warm)
Color Accuracy	83 CRI
L70 Lifespan	50,000 Hours
Lumens	567 lm
Efficacy	64.4 lm/W

## Technical Specifications

### Compliance

#### UL Listed:

Suitable for wet locations in a covered ceiling

### Construction

#### IC Rated:

Suitable for direct contact with insulation

### Trim Component:

This component can be ordered with New Construction housing in order to make a complete fixture.

[See here for New Construction Housing](#)

### Maximum Ambient Temperature:

Suitable for use in up to 40°C (104°F)

### Cold Weather Starting:

The minimum starting temperature is -40°C (-40°F)

### Lens:

Nanostructure lens eliminates "hot spots", and helps provide smooth, uniform light and higher efficiency

### Junction Box:

Integral junction box with wiring capacity for Min 60°C supply conductors  
End of Run

### Housing:

Specification-grade, die-cast aluminum construction

### Installation:

Torsion springs easily install into ceiling collar (remodeler) or rough-in (new construction)

### Trimless Look:

Flush trim for a trimless look without the hassle. Complete ceiling finishing work (spackling, sanding, painting) before installing to ensure a clean trim.

### Green Technology:

Mercury and UV free. RoHS-compliant components.

### Finish:

Our environmentally friendly polyester powder coatings are formulated for high-durability and long-lasting color

### Performance

#### Lifespan:

50,000-Hour LED lifespan based on IES LM-80 results and TM-21 calculations

#### Wattage Equivalency:

Equivalent to 50W MR16

### LED Characteristics

#### LED:

High-output, long-life LED with 2-step binning and integrated driver technology

#### Color Consistency:

2-step MacAdam Ellipse binning to achieve consistent fixture-to-fixture color

#### Color Stability:

LED color temperature is warranted to shift no more than 200K in color temperature over a 5-year period

### Electrical

#### Driver:

Constant Current, Class 2, 120VAC Only, 50/60Hz, 200mA, 0.07A

#### Dimming Driver:

TRIAC and ELV (at 120V only).  
[See dimmer compatibility guide here.](#)

### Optical

#### Optics:

40° beam spread with specular thermoplastic optics

## Technical Specifications (continued)

### Spacing Criteria:

0 to 180° (along): 0.68  
 90 to 270° (across): 0.68  
 diagonal: 0.74

### Other

#### Warranty:

RAB warrants that our LED products will be free from defects in materials and workmanship for a period of five (5) years from the date of delivery to the end user, including coverage of light output, color stability, driver performance and fixture finish. RAB's warranty is subject to all terms and conditions found at [rablighting.com/warranty](http://rablighting.com/warranty).

#### Buy American Act Compliance:

RAB values USA manufacturing! Upon request, RAB may be able to manufacture this product to be compliant with the Buy American Act (BAA). Please contact customer service to request a quote for the product to be made BAA compliant.

## Dimensions

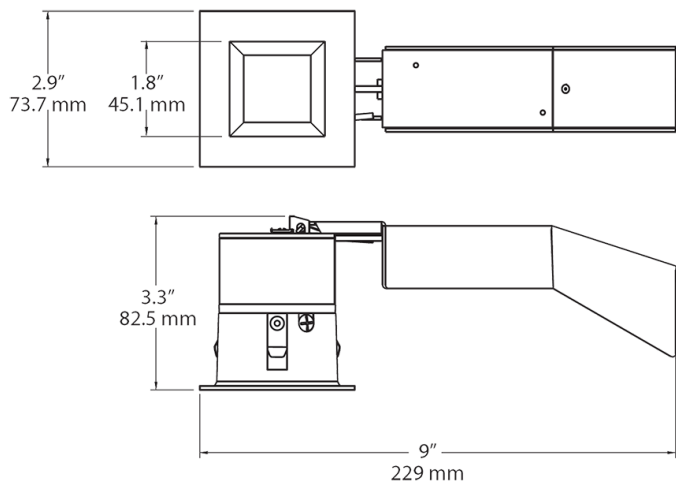

## Features

- 8W replaces 50W MR16 with energy savings of 82%
- TRIAC dimmer compatibility for additional light control
- Precision-engineered optics deliver smooth light without hot spots or glare

## Ordering Matrix

Family	Size	Shape	Wattage	Beam Spread	Color Temp	CRI	Trim	Trim Ring Color
RDLED	2	S	8	40	Y		TL	S
	2 = 2"	R = Round S = Square	8 = 8W	20 = 20 degrees 30 = 30 degrees 40 = 40 degrees W = Wall Washer	YY = 2700K Residential Warm Y = 3000K Warm YN = 3500K Warm Neutral N = 4000K Neutral	Blank = 82 or 83 CRI HC = 90 CRI	T = 1/2" Trim TL = Trimless Look	S = Matte Silver W = White B = Black Trim