



2" deep regress downlight delivers higher lumen output and reduces glare.

Color: Silver trim white cone

Weight: 2.9 lbs

Project:

Type:

Prepared By:

Date:

Driver Info

Type	Constant Current
120V	0.11A
208V	0.07A
240V	0.06A
277V	0.05A
Input Watts	11.9W

LED Info

Watts	10W
Color Temp	4000K (Neutral)
Color Accuracy	93 CRI
L70 Lifespan	100,000 Hours
Lumens	838 lm
Efficacy	70.4 lm/W

Technical Specifications

Compliance

UL Listed:

Suitable for Wet Locations. Covered Ceiling Mount Only.

Energy Star Approved:

ENERGY STAR® Version 2.0 Certified

Electrical

Driver:

Constant Current, Class 2, 120-277V, 50/60 Hz, 120V: 0.11A, 208V: 0.07A, 240V: 0.06A, 277V: 0.05A

Dimming Driver:

0 - 10V (at 120-277V), TRIAC and ELV (at 120V only). See [dimmer compatibility guide here](#).

THD:

16.2% at 120V, 26.1% at 277V

Power Factor:

98.4% at 120V, 90.3% at 277V

Surge Protection:

4kV

Optical

Optics:

40°

Performance

Lifespan:

100,000-Hour LED lifespan based on IES LM-80 results and TM-21 calculations

LED Characteristics

LEDs:

Long-life, high-efficiency, surface-mount LEDs

Color Stability:

LED color temperature is warranted to shift no more than 200K in color temperature over a 5-year period

Construction

Cold Weather Starting:

Minimum starting temperature is -35°C (-31°F)

Maximum Ambient Temperature:

Suitable for use in up to 40°C (104°F)

Housing:

Specification-grade, die-cast aluminum construction

Reflector:

Vacuum-metallized polycarbonate

Trim Ring:

Silver powder coated die cast 1/2" trim ring

Trim Cone:

White square trim cone

Lens:

Optical grade polycarbonate

Green Technology:

Mercury and UV free. RoHS-compliant components.

Other

Replacement:

Replaces 75W MR16

Warranty:

RAB warrants that our LED products will be free from defects in materials and workmanship for a period of five (5) years from the date of delivery to the end user, including coverage of light output, color stability, driver performance and fixture finish. RAB's warranty is subject to all terms and conditions found at rablighting.com/warranty.

Technical Specifications (continued)

Buy American Act Compliance:

RAB values USA manufacturing! Upon request, RAB may be able to manufacture this product to be compliant with the Buy American Act (BAA). Please contact customer service to request a quote for the product to be made BAA compliant.

Dimensions

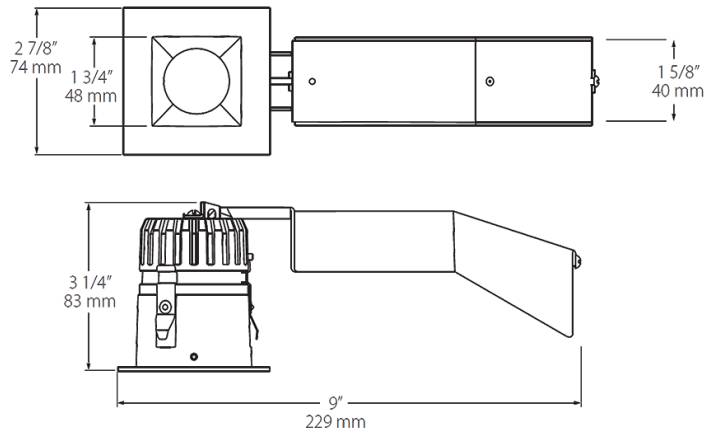

Features

- 10W replaces 75W MR16
- Universal dimming (TRIAC, ELV and 0-10V) for optimal light control
- Deep regress design improves visual cutoff and reduces glare

Ordering Matrix

Family	Size/Shape	Wattage	Driver	Optics	Color Temp	CRI	Trim Cone	Trim Ring	Trim Style
RDDLED	2S	10	D	40	N	HC	W	S	T
	2R = 2" Round 2S = 2" Square	10 = 10W	D = Universal Dimmer	20 = 20 30 = 30 40 = 40 W = Wall Wash	YY = 2700K Residential Warm Y = 3000K Warm YN = 3500K Warm Neutral N = 4000K Neutral	Blank = 80 CRI HC = 90 CRI	W = White B = Black S = Specular M = Matte	W = White B = Black S = Silver SA = Satin Aluminum	T = 1/2" Trim TL = Trimless