



2" deep regress downlight delivers higher lumen output and reduces glare.

Color: Silver trim white cone

Weight: 2.9 lbs

**Project:**

**Type:**

**Prepared By:**

**Date:**

### Driver Info

Type	Constant Current
120V	0.11A
208V	0.07A
240V	0.06A
277V	0.05A
Input Watts	12.2W

### LED Info

Watts	10W
Color Temp	2700K (Residential Warm)
Color Accuracy	82 CRI
L70 Lifespan	100,000 Hours
Lumens	918 lm
Efficacy	75.2 lm/W

## Technical Specifications

### Compliance

#### UL Listed:

Suitable for Wet Locations. Covered Ceiling Mount Only.

#### Energy Star Approved:

ENERGY STAR® Version 2.0 Certified

### Electrical

#### Driver:

Constant Current, Class 2, 120-277V, 50/60 Hz, 120V: 0.11A, 208V: 0.07A, 240V: 0.06A, 277V: 0.05A

#### Dimming Driver:

0 - 10V (at 120-277V), TRIAC and ELV (at 120V only). See [dimmer compatibility guide here](#).

#### THD:

15.8% at 120V, 27.2% at 277V

#### Power Factor:

98.5% at 120V, 90.2% at 277V

#### Surge Protection:

4kV

### Optical

#### Optics:

20°

### Performance

#### Lifespan:

100,000-Hour LED lifespan based on IES LM-80 results and TM-21 calculations

### LED Characteristics

#### LEDs:

Long-life, high-efficiency, surface-mount LEDs

#### Color Stability:

LED color temperature is warranted to shift no more than 200K in color temperature over a 5-year period

### Construction

#### Cold Weather Starting:

Minimum starting temperature is -35°C (-31°F)

#### Maximum Ambient Temperature:

Suitable for use in up to 40°C (104°F)

#### Housing:

Specification-grade, die-cast aluminum construction

### Reflector:

Vacuum-metallized polycarbonate

### Trim Ring:

Silver powder coated die cast 1/2" trim ring

### Trim Cone:

White round trim cone

### Lens:

Optical grade polycarbonate

### Green Technology:

Mercury and UV free. RoHS-compliant components.

### Other

#### Replacement:

Replaces 75W MR16

### Warranty:

RAB warrants that our LED products will be free from defects in materials and workmanship for a period of five (5) years from the date of delivery to the end user, including coverage of light output, color stability, driver performance and fixture finish. RAB's warranty is subject to all terms and conditions found at [rablighting.com/warranty](http://rablighting.com/warranty).

## Technical Specifications (continued)

### Buy American Act Compliance:

RAB values USA manufacturing! Upon request, RAB may be able to manufacture this product to be compliant with the Buy American Act (BAA). Please contact customer service to request a quote for the product to be made BAA compliant.

### Dimensions

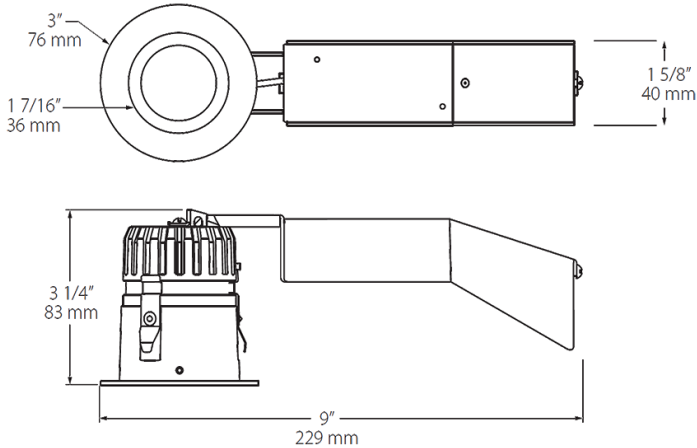

### Features

10W replaces 75W MR16

Universal dimming (TRIAC, ELV and 0-10V) for optimal light control

Deep regress design improves visual cutoff and reduces glare

### Ordering Matrix

Family	Size/Shape	Wattage	Driver	Optics	Color Temp	CRI	Trim Cone	Trim Ring	Trim Style
RDDLED	2R	10	D	20	YY		W	S	T
	2R = 2" Round 2S = 2" Square	10 = 10W	D = Universal Dimmer	20 = 20 30 = 30 40 = 40 W = Wall Wash	YY = 2700K Residential Warm Y = 3000K Warm YN = 3500K Warm Neutral N = 4000K Neutral	Blank = 80 CRI HC = 90 CRI	W = White B = Black S = Specular M = Matte	W = White B = Black S = Silver SA = Satin Aluminum	T = 1/2" Trim TL = Trimless