



Weight: 1.2 lbs

Project:

Type:

Prepared By:

Date:

Technical Specifications

Compliance

UL Listed:

Suitable for wet locations in a covered ceiling

Air Tight:

Airtight per ASTM-E283-04

Construction

IC Rated:

Suitable for direct contact with insulation

Housing:

Precision die-cast aluminum

Remodeler:

Mounting spring clips for use with 5/8" to 1" sheet rock ceilings

Green Technology:

Mercury and UV free. RoHS-compliant components.

Finish:

Formulated for high durability and long-lasting color

Other

Warranty:

RAB warrants that our LED products will be free from defects in materials and workmanship for a period of five (5) years from the date of delivery to the end user, including coverage of light output, color stability, driver performance and fixture finish. RAB's warranty is subject to all terms and conditions found at rablighting.com/warranty.

Buy American Act Compliance:

RAB values USA manufacturing! Upon request, RAB may be able to manufacture this product to be compliant with the Buy American Act (BAA). Please contact customer service to request a quote for the product to be made BAA compliant.

Dimensions

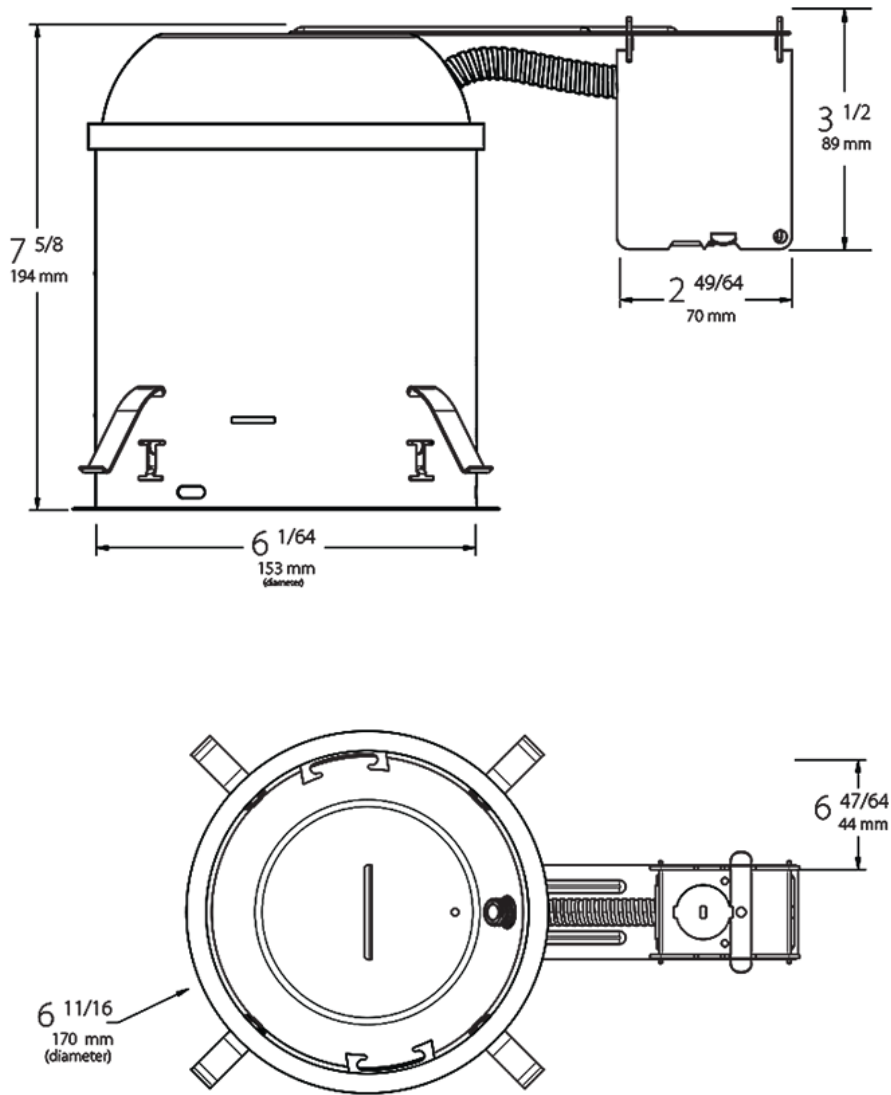

Ordering Matrix

Family	Size	Shape	Housing
RDCANIC	6	R	

4 = 4" R = Round NDCANIC = New Construction
 6 = 6" RDCANIC = Remodeler