



Project:	Type:
Prepared By:	Date:

Driver Info		LED Info	
Type	Constant Current	Watts	150W
120V	1.12A	Color Temp	5000K (Cool)
208V	0.70A	Color Accuracy	84 CRI
240V	0.60A	L70 Lifespan	100,000 Hours
277V	0.51A	Lumens	17,907 lm
Input Watts	133.9W	Efficacy	133.7 lm/W

Technical Specifications

Compliance

UL Listed:

Suitable for damp locations

IESNA LM-79 & LM-80 Testing:

RAB LED luminaires and LED components have been tested by an independent laboratory in accordance with IESNA LM-79 and LM-80.

Performance

Lifespan:

100,000-Hour LED lifespan based on IES LM-80 results and TM-21 calculations

LED Characteristics

LEDs:

Long-life, high-efficacy, surface-mount LEDs

Color Stability:

LED Color temperature is warrantied to shift no more than 200K in color temperature over a 5-year period

Color Uniformity:

RAB's range of Correlated Color Temperature follows the guidelines of the American National Standard for Specifications for the Chromaticity of Solid State Lighting (SSL) Products, ANSI C78.377-2017.

Construction

Ambient Temperature:

Suitable for use 12 hours a day, 6 days a week in 60°C (140°F). Suitable for 24/7 use in up to 55°C (131°F).

Housing:

Extruded aluminum

Lens:

High-transmittance polystyrene

Reflector:

Specular, high-reflectance aluminum with 95% reflectivity

Mounting:

V hooks (chain by others)

Other

Replacement:

Replaces 175-320W MH

Warranty:

RAB warrants that our LED products will be free from defects in materials and workmanship for a period of five (5) years from the date of delivery to the end user, including coverage of light output, color stability, driver performance and fixture finish. RAB's warranty is subject to all terms and conditions found at rablighting.com/warranty.

Buy American Act Compliance:

RAB values USA manufacturing! Upon request, RAB may be able to manufacture this product to be compliant with the Buy American Act (BAA). Please contact customer service to request a quote for the product to be made BAA compliant.

Sensor Specifications

Operating Voltage:

120-277V

Power Consumption:

1W

0-10V Sinking Current:

50mA

Adjustable High and Low Modes:

High: 0-10V; Low: off, 0-9.8V

Technical Specifications (continued)**Adjustable Time Delay:**

Amount of time in high mode with no motion before switching to low mode: 5 min., 1 -30 min.

Adjustable Cut Off Delay:

Time in which the fixture will remain on low mode with no motion before turning off and waiting for new motion to turn on: None, 1 -60 min., 1 -5 hrs.

Adjustable Sensitivity:

None, low, medium, maximum

Adjustable Setpoint:

None, 1 to 250 fc, auto

Adjustable Ramp Up and Fade Down Times:

1 to 60 sec

Operating Temperature:

-40°F to 167°F (-40°C to +75°C)

Operating Humidity:

20% to 90% noncondensing

Relay Life Rating:

200,000 cycles (120/277VAC), 50,000 cycles (230VAC)

IP Rating:

Ingress protection rating of IP66 for dust and water

UL Listed:

Suitable for Wet Locations as factory installed

Handheld Wireless Configuration Tool:

Adjust settings using handheld wireless configuration tool (catalog# WSREM). Only available with 0-10V dimming driver options. [Handheld wireless configuration tool available here.](#)

Multi Level Motion Sensor:

/WS4 sensor options use state-of-the-art surface mount technology (SMT), just like cellular phones and beepers. SMT gives you more reliability, greater RF immunity. This compact sensor that can fit neatly where others cannot. This sensor technology automatically affects the state of operation for lighting systems or individual luminaries based upon detecting the presence or absence of movement for both people as they exit/enter, or for the motion of moving vehicles within the sensors viewing area. The wide 180° viewing angle can detect movement along the entire side of a building with only one compact sensor. The hard lens is molded as part of the case, vandalproof, rainproof, bugproof and absolutely sealed. Sensor functions best when movement is across its detection pattern, not towards the sensor.

Electrical**Driver:**

Constant Current, Class 2, 120-277V, 50/60Hz, 120V: 1.12A, 208V: 0.70A, 240V: 0.60A, 277V 0.51A

THD:

7.12% at 120V, 10.05% at 277V

Power Factor:

99.8% at 120V, 94.5% at 277V

Dimensions

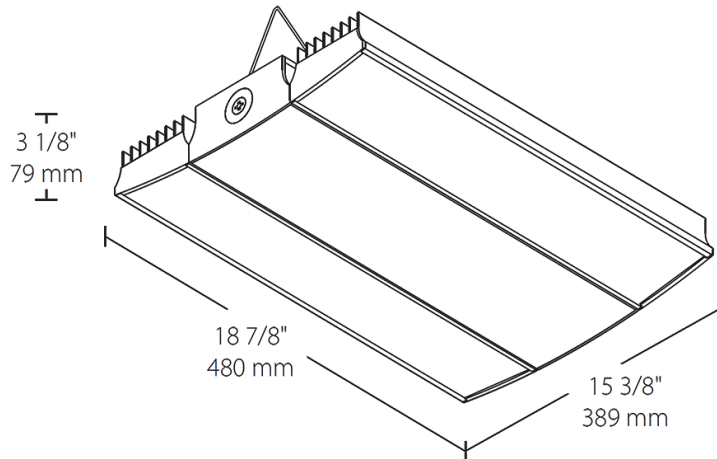

Features

- Ideal for large spaces
- 100,000-hour lifespan - virtually maintenance free operation
- 0-10V driver for variable dimming down to 10%
- Low-glare design with semi-diffuse lens

Ordering Matrix

Family	Wattage	Color Temp	Finish	Driver Options	Control Options	Other Options
RAIL	150		W	/D10	/WS4	
	150 = 150W 185 = 185W 225 = 225W 400 = 400W 95 = 95W	Blank = 5000K Cool N = 4000K Neutral YN = 3500K Warm Neutral	W = White	/D10 = 120-277V, 0-10V Dim /480/D10 = 480V, 0-10V Dim	Blank = No Option /LC/E2 = Lightcloud Controller w/Battery Pack ² /E2 = Battery Pack /LCS = Lightcloud Sensor /LC = Lightcloud Controller /LOS = LOSBAY 800 Sensor /WS4 = Multi-Level Motion Sensor 40 ft ¹ /WS2 = Multi-Level Motion Sensor 20 ft ¹ /BL = Bi-Level Control	Blank = Standard USA = BAA Compliant

¹ WS2 with 20' lens only available for 95 and 150W models; WS4 with 40' lens only available for 185 and 225W models. Both sensors only available with /D10 dimming drivers, but not with 480V driver.

² Not available in RAIL 400W