

Aluminum Pole Slipfitters for mounting fixtures or boxes to top of poles or posts. 1/2" top tap standard. 3/4" top tap on R5-3/4 and R7-3/4 only. Set screws provided.

Color: Natural

Weight: 0.4 lbs

Project:	Type:
Prepared By:	Date:

Technical Specifications

Compliance

UL Listed:

Suitable for wet locations

Material:

Aluminum

Other

Outlet Box Construction:

Precision die cast aluminum

Buy American Act Compliance:

RAB values USA manufacturing! Upon request, RAB may be able to manufacture this product to be compliant with the Buy American Act (BAA). Please contact customer service to request a quote for the product to be made BAA compliant.

Construction

Outlet Box Mounting Lugs:

16 gauge corrosion protected steel with Phillips Flat head mounting screws

Ground Screw:

#10-24 Green corrosion protected steel slotted hex washer head screw provided in pre-tapped hole

Fits Pipe:

2"

Pipe O.D.:

2 3/8

Dimensions

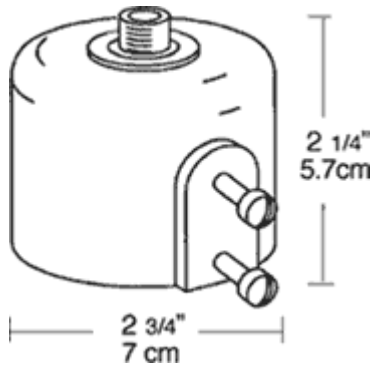

Features

- Heavy die cast aluminum
- Set screws provided