



Project:	Type:
Prepared By:	Date:

Technical Specifications

Performance

Product Type:

Compacts

Input Wattage:

3.5W

Lumens (Nominal):

340lm

Efficacy:

97lm/W

L70 Lifespan:

50,000-Hour LED lifespan based on IES LM-80 results and TM-21 calculations

Wattage Equivalency:

7W/9W G23

LED Characteristics

Color Accuracy (CRI):

80

Color Temperature:

3000K

Electrical

THD:

20%

Power Factor:

>0.9

Dimmable:

Non-Dim

Input Voltage:

120-277 Type B (Type A dependent on ballast)

Operating Frequency:

50/60Hz

Operating Temperature:

-20°C to 45°C (-4°F to 113°F)

Construction

Bulb Shape:

PLS-Horizontal

Enclosure Material:

Polycarbonate

Housing Finish:

White

Lens Finish:

Frosted

Base Type:

2-Pin G23

Optical

Beam Angle:

120°

Installation

Installation Method:

UL Type A with Magnetic Ballasts & UL Type B (Dual Mode)

Burning Position:

Horizontal

Other

Technology EQ:

CFL

Warranty:

RAB warrants that our LED products will be free from defects in materials and workmanship for a period of five (5) years from the date of delivery to the end user, including coverage of light output, color stability, driver performance and fixture finish. RAB's warranty is subject to all terms and conditions found at rablighting.com/warranty.

Technical Specifications (continued)

Buy American Act Compliance:

RAB values USA manufacturing! Upon request, RAB may be able to manufacture this product to be compliant with the Buy American Act (BAA). Please contact customer service to request a quote for the product to be made BAA compliant.

Compliance

Listings:

UL Listed, UL Classified

Environment/Fixture Rating:

Damp / Enclosed

RoHS:

Mercury and UV free. RoHS-compliant components.

FCC:

Complies with Part 15B of the FCC Rules

Model Number for Certification:

T10203(PLS-3.5-H-830-HYB)

Minimum Compartment Size

Length x Width x Height [in]	Lamp Quantity
6	1

Case and Pallet Dimensions

	QTY	LENGTH (in)	WIDTH (in)	HEIGHT (in)
CASE	12	0	0	0
PALLET	1392	0	0	0

Dimension

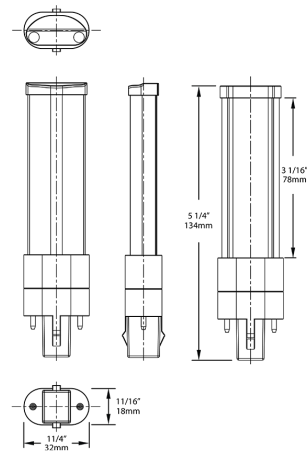

Light Distribution

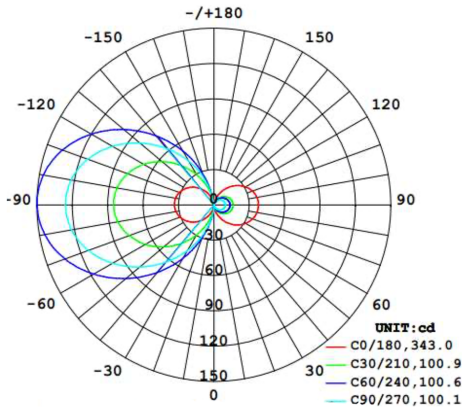

Features

- Replaces 13W CFL Lamps
- Plug and Play on existing magnetic CFL ballasts or can be wired directly to line voltage without need for an external driver or ballast
- Compatible with Gx23 base installations
- 50,000 hour Lifespan
- Environmentally friendly, no mercury used
- UL Classified
- Rated for use in enclosed and open fixtures in dry or damp locations
- 5 Year No Compromise Warranty

Ordering Matrix

Family	Wattage	Orientation	CRI/Color Temp	Installation Type
PLS	3.5	H	830	HYB
	3.5 = 3.5W 5 = 5W 5.2 = 5.2W	H = Horizontal	840 = 80 CRI, 4000K 835 = 80 CRI, 3500K 830 = 80 CRI, 3000K 827 = 80 CRI, 2700K	HYB = Hybrid