

Project:	Type:	Prepared By:	Date:
-----------------	--------------	---------------------	--------------



Features and Benefits

- Produces rich and vibrant colors >90CRI
- Energy efficient replacement for incandescent and halogen PAR lamps
- Constructed from durable materials which lowers risk of breakage
- Rated for use in enclosed and open fixtures in dry and damp locations*
- Single optic and full face lens for precise beam angle control
- Longer lifespan compared to legacy equivalents minimizes replacement and maintenance costs
- Title 20 Compliant, ENERGY STAR Compliant, UL Listed
- Dimmable down to 10% (check dimmer compatibility list)
- *PAR38 is wet rated

Technical Specifications		
Performance <hr/> Product Type: PAR Input Wattage: 12W Lumens (Nominal): 950lm Efficacy: 79lm/W L70 Lifespan: 40,000 Hours Construction <hr/> Bulb Shape: PAR38 Base Type: E26 Edison For Use Outdoors in Open Fixtures: Yes	LED Characteristics <hr/> Color Temperature: 4000K Cool White Color Accuracy (CRI): 90 CRI Electrical <hr/> Power Factor: 0.9 Operating Temperature: -20°C to 45°C (-4°F to 113°F) Dimmable: Yes, down to 10% Input Voltage: 120V Flicker: <30% Optical <hr/> Beam Angle: 25°	Other <hr/> Warranty: RAB warrants that our LED products will be free from defects in materials and workmanship for a period of four (4) years from the date of delivery to the end user, including coverage of light output, color stability, driver performance and fixture finish. RAB's warranty is subject to all terms and conditions found at rablighting.com/warranty . Compliance <hr/> UL Listed: Yes Energy Star Approved: This product is ENERGY STAR® Version 2.0 Certified Energy Star ID: 2329958 California Energy Commission (CEC) Status: Lawful for Sales in California

Case and Pallet Dimensions

	QTY	LENGTH (in)	WIDTH (in)	HEIGHT (in)
CASE	6	14.9	10	6
PALLET	432	44.7	39.8	49.5

Dimension

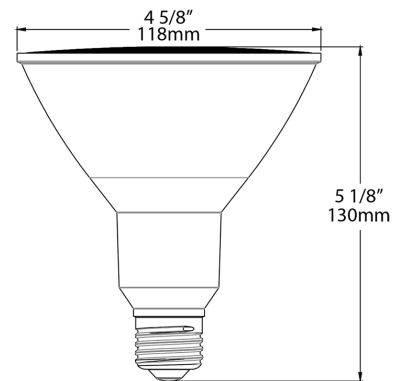

Light Distribution

