



<b>Project:</b>	<b>Type:</b>
<b>Prepared By:</b>	<b>Date:</b>

## Technical Specifications

### Performance

**Product Type:**

PAR38

**Description:**

This dimmable, PAR38 is a perfect replacement for legacy halogen lamps. This lamp offers >80 CRI, wet rated, and great for use outdoors.

**Wattage Equivalency:**

120W Halogen

**Input Wattage:**

12.5W

**Lumens (Nominal):**

1,200lm

**Efficacy:**

96lm/W

**L70 Lifespan:**

25,000-Hour LED lifespan based on IES LM-70 results

**Beam Angle:**

40-degree

### Electrical

**THD:**

<80%

**Power Factor:**

>0.7

**Dimmable:**

Yes, TRIAC/ELV  
See Dimmer Compatibility List

**Input Voltage:**

120V

**Operating Frequency:**

60 Hz

**Operating Temperature:**

-13°F to 113°F (-25°C to 45°C)

### LED Characteristics

**Color Accuracy (CRI):**

≥80 CRI

**R9 Value:**

High color performance with R9 greater than or equal to 0

**Color Consistency:**

<6-step MacAdam Ellipse binning to achieve consistent fixture-to-fixture color

### Construction

**Base Type:**

E26 Edison

**Finish:**

White

**Bulb Shape:**

PAR38

**Endcap Material:**

Nickel-Aluminum

**Enclosure Material:**

Plastic

**Lens:**

Single optic and full face lens for precise beam angle control

### Compliance

**Listings:**

UL Listed

**Environment:**

Suitable for use in indoor and outdoor application in dry, damp, and wet environments

**Fixture Rating:**

Suitable for use in enclosed fixtures

**Energy Star Approved:**

This product is ENERGY STAR® Version 2.2 Certified

## Technical Specifications (continued)

**T20 Compliant:**

Not Compliant

**California Title 24 JA8 Compliant:**

Not Compliant

**California Energy Commission (CEC) Status:**

Not Lawful for Sales in California

**NSF Listed:**

No

**RoHS:**

Mercury and UV free. RoHS-compliant components.

**FCC:**

Complies with Part 15B of the FCC Rules

**Other**

**Warranty:**

RAB warrants that our LED products will be free from defects in materials and workmanship for a period of three (3) years from the date of delivery to the end user, including coverage of light output, color stability, driver performance and fixture finish. RAB's warranty is subject to all terms and conditions found at [rablighting.com/warranty](http://rablighting.com/warranty).

**Note:**

All values are typical (tolerance +/- 10%)

**Buy American Act Compliance:**

RAB values USA manufacturing! Upon request, RAB may be able to manufacture this product to be compliant with the Buy American Act (BAA). Please contact customer service to request a quote for the product to be made BAA compliant.

## Case and Pallet Dimensions

	QTY	LENGTH (in)	WIDTH (in)	HEIGHT (in)
CASE	6	15.354	10.354	6
PALLET	480	46.063	36.063	49.449

## Dimension

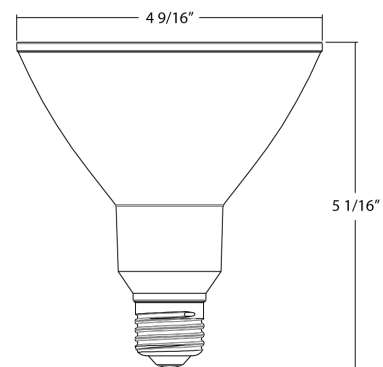

## Features

- Energy efficient replacement for incandescent and halogen PAR lamps
- Constructed from durable materials which lowers risk of breakage
- Rated for use in enclosed and open fixtures in wet locations
- Single optic and full face lens for precise beam angle control
- Longer lifespan compared to legacy equivalents minimizes replacement and maintenance costs
- Replacements for halogen PAR lamps. Dimmable LED with 80 CRI and wet rated, great for use outdoors.