

Project:	Type:	Prepared By:	Date:
-----------------	--------------	---------------------	--------------



Features and Benefits

- Produces rich and vibrant colors >90CRI
- Energy efficient replacement for incandescent and halogen PAR lamps
- Constructed from durable materials which lowers risk of breakage
- Rated for use in enclosed and open fixtures in dry and damp locations*
- Single optic and full face lens for precise beam angle control
- Longer lifespan compared to legacy equivalents minimizes replacement and maintenance costs
- Title 20 Compliant, ENERGY STAR Compliant, UL Listed
- Dimmable down to 10% (check dimmer compatibility list)
- *PAR38 is wet rated

Technical Specifications		
<p>Performance</p> <p>Product Type: PAR</p> <p>Input Wattage: 7W</p> <p>Wattage Equivalency: 50W Halogen</p> <p>Lumens (Nominal): 550lm</p> <p>Efficacy: 79lm/W</p> <p>L70 Lifespan: 40,000 Hours</p> <p>Construction</p> <p>Bulb Shape: PAR20</p> <p>Base Type: E26 Edison</p>	<p>For Use Outdoors in Open Fixtures: No</p> <p>LED Characteristics</p> <p>Color Temperature: 3000K Warm White</p> <p>Color Accuracy (CRI): 90 CRI</p> <p>Electrical</p> <p>Power Factor: 0.9</p> <p>Operating Temperature: -20°C to 45°C (-4°F to 113°F)</p> <p>Dimmable: Yes, down to 10%</p> <p>Input Voltage: 120V</p> <p>Flicker: <30%</p>	<p>Optical</p> <p>Beam Angle: 25°</p> <p>Other</p> <p>Warranty: RAB warrants that our LED products will be free from defects in materials and workmanship for a period of four (4) years from the date of delivery to the end user, including coverage of light output, color stability, driver performance and fixture finish. RAB's warranty is subject to all terms and conditions found at rablighting.com/warranty.</p> <p>Compliance</p> <p>UL Listed: Yes</p> <p>Energy Star Approved: This product is ENERGY STAR® Version 2.0 Certified</p> <p>Energy Star ID: 2329947</p>

Technical Specifications (continued)

California Energy Commission (CEC) Status:
Lawful for Sales in California

Case and Pallet Dimensions

	QTY	LENGTH (in)	WIDTH (in)	HEIGHT (in)
CASE	12	10.8	8.1	4
PALLET	2880	43.2	37.9	48.7

Dimension

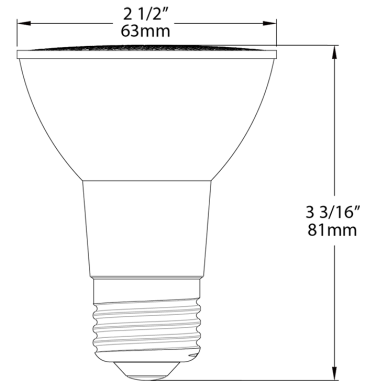

Light Distribution

