

Project:	Type:	Prepared By:	Date:
-----------------	--------------	---------------------	--------------



Features and Benefits

- Energy efficient replacement for incandescent and halogen Small diameter reflectors
- Constructed from durable materials which lowers risk of breakage
- Rated for use in enclosed and open fixtures in dry or damp locations
- Single optic and full face lens for precise beam angle control
- Longer lifespan compared to legacy equivalents minimizes replacement and maintenance costs
- ENERGY STAR Compliant, UL Listed

Technical Specifications		
<p>Performance</p> <p>Product Type: PAR</p> <p>Input Wattage: 6.5W</p> <p>Lumens (Nominal): 500lm</p> <p>Efficacy: 76.9lm/W</p> <p>L70 Lifespan: 25,000-Hour LED lifespan based on IES LM-70 results</p> <p>Wattage Equivalency: 50W Halogen</p> <p>Compliance</p> <p>UL Listed: Suitable for damp locations</p> <p>Enclosed Fixtures: Suitable for use in enclosed fixtures</p>	<p>LED Characteristics</p> <p>Color Temperature: 5000K</p> <p>Color Accuracy (CRI): 80 CRI</p> <p>Electrical</p> <p>Power Factor: 0.7</p> <p>Dimmable: Yes</p> <p>Operating Temperature: -20°C to 45°C (-4°F to 113°F)</p> <p>Input Voltage: 120V</p> <p>Operating Frequency: 60 Hz</p> <p>Construction</p> <p>Bulb Shape: PAR16</p>	<p>Base Type: E26 Edison</p> <p>Enclosure Material: Plastic</p> <p>Optical</p> <p>Beam Angle: 40°</p> <p>Other</p> <p>Warranty: RAB warrants that our LED products will be free from defects in materials and workmanship for a period of four (4) years from the date of delivery to the end user, including coverage of light output, color stability, driver performance and fixture finish. RAB's warranty is subject to all terms and conditions found at rablighting.com/warranty.</p>

Case and Pallet Dimensions

	QTY	LENGTH (in)	WIDTH (in)	HEIGHT (in)
CASE	12	8.6	6.5	4
PALLET	4320	44.49	40.47	43.94

Dimension

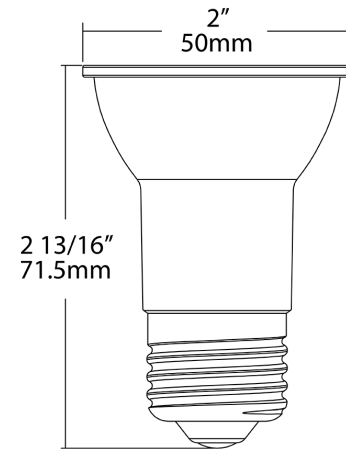

Light Distribution

