

Project:	Type:
Prepared By:	Date:

Driver Info		LED Info	
Type	Constant Current	Watts	38W
120V	0.31A	Color Temp	4000K (Neutral)
208V	0.19A	Color Accuracy	92 CRI
240V	0.17A	L70 Lifespan	100,000 Hours
277V	0.14A	Lumens	N/A
Input Watts	38W	Efficacy	N/A

Technical Specifications

Lightcloud

Lightcloud Controller Installed:

Fixture, Zone, and plug-load control from one powerful device. Capable of switching, 0-10V dimming, power monitoring. Can also be used to extend the range of the Lightcloud mesh network. Attach to fixture, junction box, or electrical panel. [Learn more about Lightcloud.](#)

Compliance

UL Listed:

Suitable for wet locations in a covered ceiling

Electrical

Driver:

Class 2, Constant Current, 50-60Hz, 900mA

Dimming:

Universal dimming driver for 0-10V (at 120-277V), TRIAC or ELV (at 120V only). [See dimmer compatibility guide here.](#)

Surge Protection:

6kV

Construction

Housing Component:

This component must be ordered with New Construction Downlights Trim Module in order to make a complete fixture. [See here for Retrofit Reflectors.](#)

Housing:

Formed galvanized steel construction

Cold Weather Starting:

The minimum starting temperature is -30°C (-22°F)

Maximum Ambient Temperature:

Suitable for use in up to 35°C (95°F)

Lens:

Diffusion lens for smooth and even light distribution

Reflector:

Spun aluminum

Heat Sink:

Die-cast aluminum with external fins for maximum heat dissipation

Finish:

Formulated for high durability and long-lasting color

Green Technology:

Mercury and UV free. RoHS-compliant components.

Performance

Lifespan:

100,000-Hour LED lifespan based on IES LM-80 results and TM-21 calculations

LED Characteristics

LEDs:

Long-life, high-efficiency surface-mount LEDs with 3 step binning

Color Consistency:

3-step MacAdam Ellipse binning to achieve consistent fixture-to-fixture color

Other

Warranty:

RAB warrants that our LED products will be free from defects in materials and workmanship for a period of ten (10) years from the date of delivery to the end user, including coverage of light output, color stability, driver performance and fixture finish. RAB's warranty is subject to all terms and conditions found at rablighting.com/warranty.

Technical Specifications (continued)

Replacement:

Replaces 50 Watt Metal Halide and 32 Watt CFL

Buy American Act Compliance:

RAB values USA manufacturing! Upon request, RAB may be able to manufacture this product to be compliant with the Buy American Act (BAA). Please contact customer service to request a quote for the product to be made BAA compliant.

Dimensions

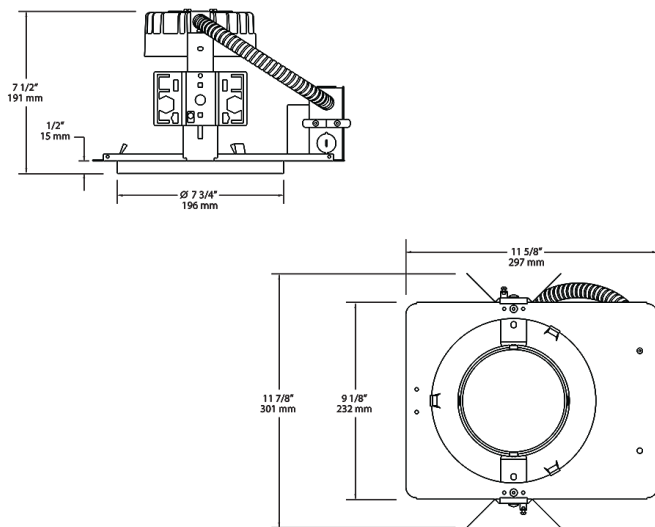

Features

Universal driver is compatible with TRIAC, ELV and 0-10V dimmers

Lightweight design for easy installation and increased safety

100,000-Hour LED lifespan

Ordering Matrix

Family	Size	Shape	Wattage	Color Temp	CRI	Lightcloud
NDLED	7	R	38	N	HC	/LC
7 = 7"		R = Round	30 = 30W 38 = 38W	YY = 2700K Residential Warm Y = 3000K Warm YN = 3500K Warm Neutral N = 4000K Neutral	Blank = 82 CRI HC = 92 CRI	Blank = No Lightcloud® /LC = Lightcloud® Controller