

Project:

Type:

Prepared By:

Date:



UPC: 019813510521

Features and Benefits

Produces rich and vibrant colors >90CRI

Energy efficient replacement for incandescent and halogen Small diameter reflectors

Constructed from durable materials which lowers risk of breakage

Rated for use in enclosed and open fixtures in dry or damp locations

Single optic and full face lens for precise beam angle control

Longer lifespan compared to legacy equivalents minimizes replacement and maintenance costs

Title 20 Compliant, ENERGY STAR Compliant, UL Listed

Compatible with low voltage transformers (check compatibility list)

Technical Specifications

Performance

Product Type:

Small-Reflector

Input Wattage:

6.5W

Wattage Equivalency:

50W Halogen

Lumens (Nominal):

500lm

Efficacy:

77lm/W

L70 Lifespan:

25,000 Hours

Construction

Bulb Shape:

MR16

Base Type:

GU5.3

For Use Outdoors in Open Fixtures:

No

LED Characteristics

Color Temperature:

3000K Warm White

Color Accuracy (CRI):

≥90

Electrical

Power Factor:

>0.9

Operating Temperature:

-20°C to 45°C (-4°F to 113°F)

Dimmable:

Yes

Input Voltage:

12V

Flicker:

≤30%

Optical

Beam Angle:

25°

Other

Warranty:

RAB warrants that our LED products will be free from defects in materials and workmanship for a period of five (5) years from the date of delivery to the end user, including coverage of light output, color stability, driver performance and fixture finish. RAB's warranty is subject to all terms and conditions found at rablighting.com/warranty.

Compliance

UL Listed:

Yes

Energy Star Approved:

This product is ENERGY STAR® Version 2.0 Certified

Energy Star ID:

2351921

Technical Specifications (continued)

Model Number for Certification:
R10025

California Energy Commission (CEC) Status:
Lawful for Sales in California

Case and Pallet Dimensions

	QTY	LENGTH (in)	WIDTH (in)	HEIGHT (in)
CASE	12	8.74	6.61	2
PALLET	5760	44.49	40.47	45.35

Dimension

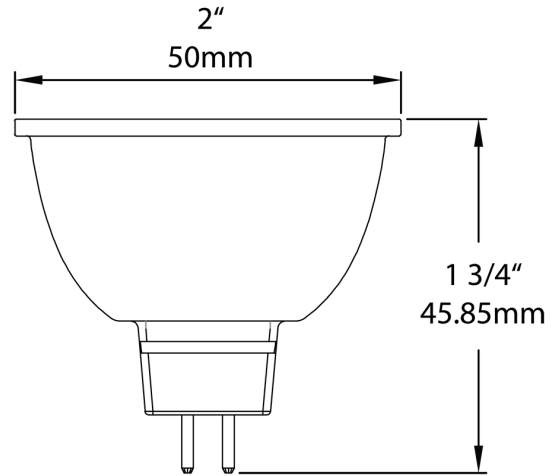

Light Distribution

