

Project:

Type:

Prepared By:

Date:



UPC: 019813510415

### Features and Benefits

Produces rich and vibrant colors >90CRI

Energy efficient replacement for incandescent and halogen Small diameter reflectors

Constructed from durable materials which lowers risk of breakage

Rated for use in enclosed and open fixtures in dry or damp locations

Single optic and full face lens for precise beam angle control

Longer lifespan compared to legacy equivalents minimizes replacement and maintenance costs

Title 20 Compliant, ENERGY STAR Compliant, UL Listed

Compatible with low voltage transformers (check compatibility list)

## Technical Specifications

### Performance

#### Product Type:

Small-Reflector

#### Input Wattage:

5W

#### Wattage Equivalency:

35W Halogen

#### Lumens (Nominal):

400lm

#### Efficacy:

80lm/W

#### L70 Lifespan:

25,000 Hours

### Construction

#### Bulb Shape:

MR16

#### Base Type:

GU5.3

#### For Use Outdoors in Open Fixtures:

No

### LED Characteristics

#### Color Temperature:

2700K Soft White

#### Color Accuracy (CRI):

≥90

### Electrical

#### Power Factor:

>0.9

#### Operating Temperature:

-20°C to 45°C (-4°F to 113°F)

#### Dimmable:

Yes

#### Input Voltage:

12V

#### Flicker:

≤30%

### Optical

#### Beam Angle:

15°

### Other

#### Warranty:

RAB warrants that our LED products will be free from defects in materials and workmanship for a period of five (5) years from the date of delivery to the end user, including coverage of light output, color stability, driver performance and fixture finish. RAB's warranty is subject to all terms and conditions found at [rablighting.com/warranty](http://rablighting.com/warranty).

### Compliance

#### UL Listed:

Yes

#### Energy Star Approved:

This product is ENERGY STAR® Version 2.0 Certified

#### Energy Star ID:

2351517

**Technical Specifications (continued)**

**Model Number for Certification:**  
R10014

**California Energy Commission (CEC) Status:**  
Lawful for Sales in California

**Case and Pallet Dimensions**

	QTY	LENGTH (in)	WIDTH (in)	HEIGHT (in)
CASE	12	8.74	6.61	2
PALLET	5760	44.49	40.47	45.35

**Dimension**

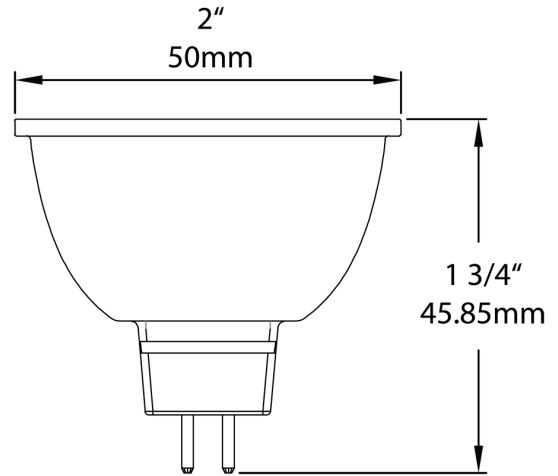

**Light Distribution**

