



Flush mount canopy fixture ideal for vehicle service and fueling stations as a retrofit or new construction installation. 16" x 16" models offered in two power packages with an equivalency range from 150W to 250W Metal Halide. Also available in 20" x 20" models with three power packages.

Color: White

Weight: 26.7 lbs

Project:	Type:
Prepared By:	Date:

Driver Info		LED Info	
Type	Constant Current	Watts	80W
120V	N/A	Color Temp	5000K (Cool)
208V	N/A	Color Accuracy	74 CRI
240V	N/A	L70 Lifespan	100,000 Hours
277V	N/A	Lumens	12,207 lm
Input Watts	86.3W	Efficacy	141.4 lm/W

Technical Specifications

Compliance

UL Listed:

Suitable for wet locations

IP Rating:

Ingress protection rating of IP66 for dust and water

IESNA LM-79 & lm-80 Testing:

RAB LED luminaires and LED components have been tested by an independent laboratory in accordance with IESNA lm-79 and lm-80

Optical

BUG Rating:

B3 U0 G1

Construction

Maximum Ambient Temperature:

Suitable for use in up to 40°C (104°F)

Cold Weather Starting:

The minimum starting temperature is -40°C (-40°F)

Housing:

Die-cast aluminum with stainless steel cover

Mounting:

Semi-recessed construction. Junction box with four (4) 1/2" NPS conduit openings.

Gaskets:

High-temperature silicone gaskets

Retroplate:

An optional retroplate allows for installation in openings from 4 to 6.5 inches in diameter. Additional retrofit options are available upon request to replace virtually any existing fixture. Please contact RAB Customer Service 1-888-722-1000.

Finish:

Our environmentally friendly polyester powder coatings are formulated for high-durability and long-lasting color

Green Technology:

Mercury and UV free. RoHS-compliant components.

Performance

Lifespan:

100,000-Hour LED lifespan based on IES LM-80 results and TM-21 calculations

Wattage Equivalency:

Equivalent to 250W Metal Halide

LED Characteristics

LEDs:

Long-life, high-efficacy, surface-mount LEDs

Color Consistency:

7-step MacAdam Ellipse binning to achieve consistent fixture-to-fixture color

Color Stability:

RAB LEDs exceed industry standards for chromatic stability

Color Uniformity:

RAB's range of Correlated Color Temperature follows the guidelines of the American National Standard for Specifications for the Chromaticity of Solid State Lighting (SSL) Products, ANSI C78.377-2017.

Other

Warranty:

RAB warrants that our LED products will be free from defects in materials and workmanship for a period of five (5) years from the date of delivery to the end user, including coverage of light output, color stability, driver performance and fixture finish. RAB's warranty is subject to all terms and conditions found at rablighting.com/warranty.

Buy American Act Compliance:

RAB values USA manufacturing! Upon request, RAB may be able to manufacture this product to be compliant with the Buy American Act (BAA). Please contact customer service to request a quote for the product to be made BAA compliant.

Technical Specifications (continued)

Electrical

Driver:

Constant Current, Class 2 347-480V, 50/60 Hz. THD <20%. PF >0.90, 550mA

Dimensions

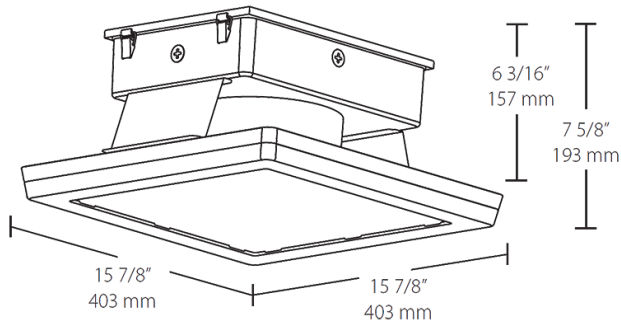

Features

- All 120-277V models DLC Premium listed, qualifying for highest available utility rebates
- Premium performance, ultra-high efficiency for fastest payback
- Easily installs in 4" openings and replaces most existing fixtures
- Retroplate accessory available for openings larger than 4"
- Water-resistant junction box and drain-off slots
- 5-Year, No-Compromise Warranty

Ordering Matrix

Family	Size		Wattage	Color Temp	Finish	Driver Options
MASI	16	-	80		W	/480
	20 = 20" x 20" 16 = 16" x 16"		52 = 52W 80 = 80W 100 = 100W 160 = 160W 200 = 200W	Blank = 5000K Cool N = 4000K Neutral Y = 3000K Warm	W = White	/D10 = 120-277V w/ 0-10V Dimming /480 = 480V On/Off Driver