

# INSTRUCTIONS

## LU160™ INSTALLATION

# RAB®

RAB Lighting is committed to creating high-quality, affordable, well-designed and energy-efficient LED lighting and controls that make it easy for electricians to install and end users to save energy. We'd love to hear your comments. Please call the Marketing Department at 888-RAB-1000 or email: [marketing@rablighting.com](mailto:marketing@rablighting.com)



LUMINATOR

### IMPORTANT

**CAUTION:** All wiring **MUST** comply with local electrical codes and should be installed by qualified electrician. Read entire Installation Manual before proceeding. **TURN OFF POWER BY REMOVING POWER FUSE OR TURNING OFF CIRCUIT BREAKER BEFORE INSTALLATION.**

The motion detector will not operate correctly if it is installed:

- Near an air conditioning and/or heating unit
- LU160 cannot be used with a dimmer switch, motion or occupancy sensor and other electronic switching devices unless otherwise designated. LU160 must be powered directly off a switch circuit.
- These instructions do not cover all details or variations in equipment nor do they provide for every possible situation during installation, operation or maintenance.

### WARNING: RISK OF ELECTRICAL SHOCK

- Turn off electrical power at fuse or circuit breaker box before wiring fixture to the power supply.
- Verify that the supply voltage is correct. Connect fixture to a 120 volt, 60 Hz power source.

## PRE-INSTALLATION

- Install the motion sensor between 3-10ft above the ground. Motion sensor is less sensitive above 10ft.
- Mount motion sensor so motion moves across detection zone as shown in Fig 1.
- Mount sensor away from heat producing sources to prevent false triggering.
- Mount motion sensor away from moving objects such as trees and street traffic.
- Suitable for wall mounting or eave mounting as shown in Fig 2.

## MOUNTING LOCATIONS

- Determine the mounting location - a Wall or Eave.
- Make sure "This side UP" on sensor faces up after installation.
- Position the lamp head in the general direction of the desired light coverage.
- If needed, adjust the motion sensor up and down so the controls faces the ground after installation.

**Note: Do not mount this light fixture on the ground.**

Fig: 1

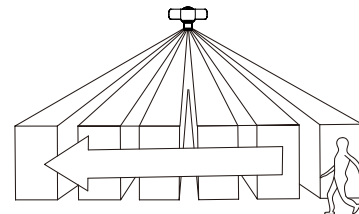

Sensor detects motion that moves across the detection zone

Fig: 2

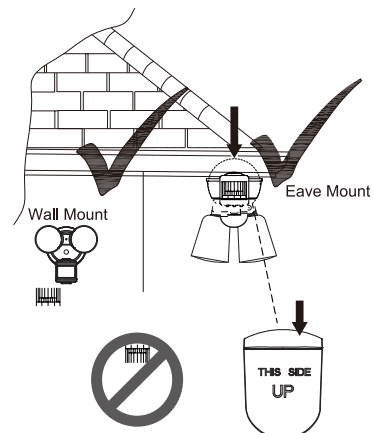

# INSTRUCTIONS

## LU160™ INSTALLATION

# RAB®

RAB Lighting is committed to creating high-quality, affordable, well-designed and energy-efficient LED lighting and controls that make it easy for electricians to install and end users to save energy. We'd love to hear your comments. Please call the Marketing Department at 888-RAB-1000 or email: [marketing@rablighting.com](mailto:marketing@rablighting.com)

### INSTALLATION

#### Step 1: Installing the Mounting Bracket (see parts list on last page)

1. Line up the holes on the **Mounting Bracket** with the holes on your **Junction Box**. Using the two **Mounting Screws** (F or G).
2. Attach the Ground wire to the Mounting Bracket (E), using Ground Screw (K).

Fig: 3

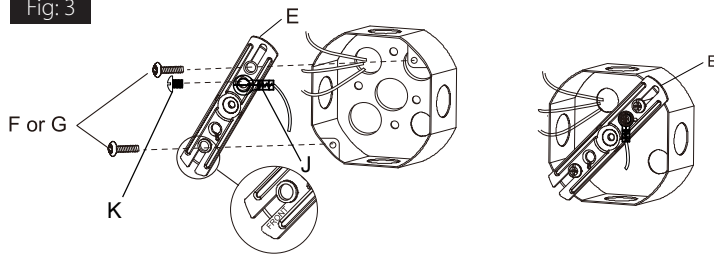

#### Step 2: Making the Electrical Connections.

**Caution: Do not cut any wires with factory installed wire connectors or remove the wire connectors**

1. Connect the light fixture wires to the junction box wires with wire nuts (I) as shown in Fig 4.
2. White to **Neutral**  
Black to **Line**  
Green ground wire to **House ground**

**Note: Make sure the polarity is correct.**

Fig: 4

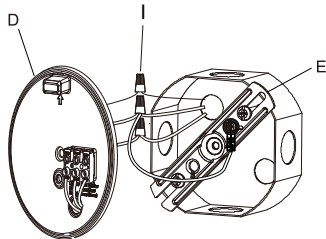

#### Step 3: Installing the Mounting Plate.

1. Place the **Mounting Plate** (D) against the **Junction Box** (Fig. 4).
2. When mounting to a wall, the **"UP"** arrow must point upward.
3. When mounting to an eave, the **"UP"** arrow must point toward the building as shown in Fig 5.
4. Insert the small mounting bolt (B) through the **Mounting Plate** (D) hole and **Mounting Bracket** (E) hole. Tighten the bolt (B) securely.
5. Firmly pull on the **Mounting Plate** (D) to verify it is securely attached to the **Mounting Bracket** (E).

Fig: 5

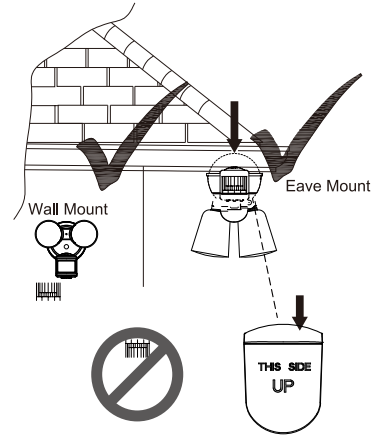

#### Step 4: Mounting the Light Fixture.

1. Align the bottom edge of the light fixture (A) with the bottom edge of the **Mounting Plate** (D). Tilt the light fixture (A) toward the **Mounting Plate** (D), making sure the light fixture (A) is centered on the **Mounting Plate** (D) as shown in Fig 6.
2. Tighten the large pre-installed **Mounting Bolt** (H) securely through the center of the **Mounting Plate** (D). Do not overtighten.
3. Push the **Decorative Cap** (C) firmly into the large **Mounting Bolt Hole** on the light fixture (A).

Fig: 6

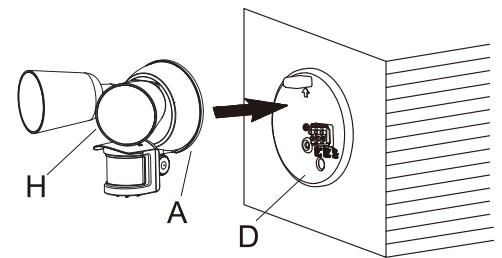

#### Step 5: Caulking Around the Light Fixture.

1. Caulk around the canopy and mounting surface with silicone sealant (*not included*) as shown in Fig 7.

Fig: 7

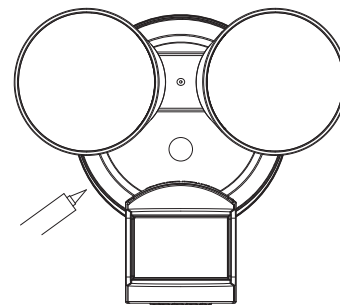

# INSTRUCTIONS

## LU160™ INSTALLATION



RAB Lighting is committed to creating high-quality, affordable, well-designed and energy-efficient LED lighting and controls that make it easy for electricians to install and end users to save energy. We'd love to hear your comments. Please call the Marketing Department at 888-RAB-1000 or email: marketing@rablighting.com

### OPERATION

#### Step 1: Adjusting the Lamp Heads and Sensor.

1. Lamp heads can be adjusted easily. You may adjust the lamp head left and right or up and down to get the desired lamp direction as shown in Fig 8.
2. Sensor can be adjusted easily. You may adjust the sensor left and right or up and down to get the desired position.

Fig: 8

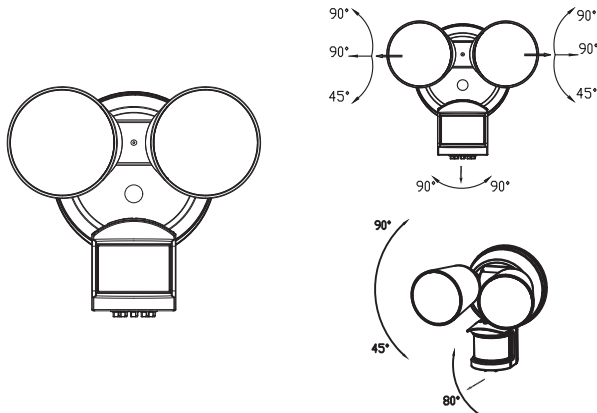

**Note: LED LAMPS ARE NON-REPLACEABLE.** Do not attempt to access or maintain the LEDs; they are non-replaceable and any contact may damage the LEDs and will void the warranty.

#### Default settings:

- Dimmer: 2096lm
- CCT: 4000K
- LUX: Night only
- Time: 1 Min
- Sensitivity: 25ft

#### Step 2: Adjusting the Detector.

1. After installing your motion activated light, you are ready to set/aim the motion detector.
2. Detection Range is as shown below, Fig. 9.
3. Adjust the sensor head up or down for longer or shorter coverage. Rotate the motion sensor so the controls face toward the ground shown in Fig 10.

Fig: 9

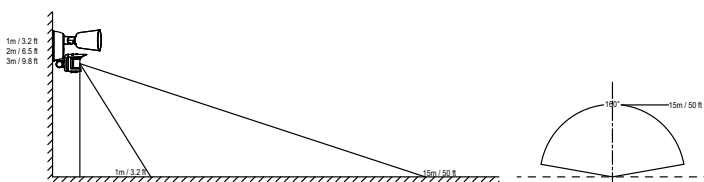
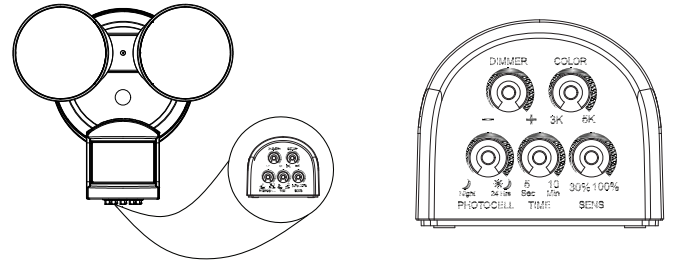

Fig: 10



#### Sensor Detection Range (SENS) Switch.

Adjust the **SENS** setting to adjust range of Passive Infrared (PIR) Motion Sensor.

Slide the "**SENS**" switch toward the **30%** (low) position for short detection range.

Slide the "**SENS**" switch toward the **100%** (high) position for long detection range.

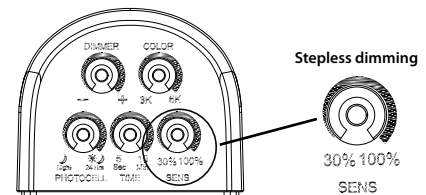

#### Time Setting.

Adjust the timer for how long the Security Floodlight will be activated when motion is detected.

Set the "**TIME**" switch to the **5 sec** position is 5 seconds, switch to the **10 min** position is 10 minutes.

The Security Floodlight will remain on when motion is detected. It will automatically turn off when motion is no longer sensed and the set time expired.

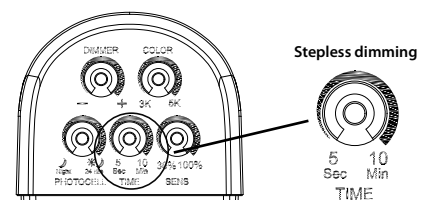

# INSTRUCTIONS

## LU160™ INSTALLATION



RAB Lighting is committed to creating high-quality, affordable, well-designed and energy-efficient LED lighting and controls that make it easy for electricians to install and end users to save energy. We'd love to hear your comments. Please call the Marketing Department at 888-RAB-1000 or email: [marketing@rablighting.com](mailto:marketing@rablighting.com)

### OPERATION (cont'd)

#### Dusk Level / Ambient Light sensor (LUX) Setting.

This setting is used to control when the security light will be activated relative to the ambient natural light.

When sliding the "LUX" switch toward the ☀ position, the light will turn on in the daylight, sunset, or in darkness.

When sliding the "LUX" switch toward the 🌙 position, the light will only turn on in the darkness.

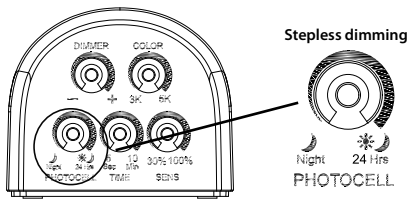

#### Dimmer Setting.

Adjust the brightness of the Floodlight when activated.

Set the "DIMMER" to the — position for 10% brightness, adjust to the + position for 100% brightness.

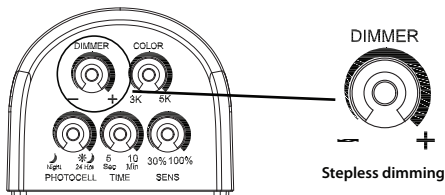

#### Color Setting.

Adjust the LED color temperature of the Floodlight when activated.

Set the "COLOR" dial to the 3K position for 3000K, adjust to the 5K position for 5000K (Color Temperature range is 3000K - 5000K)

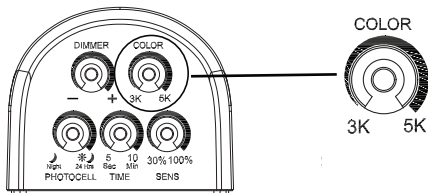

#### Step 3: Manual Override Function.

1. When power is on, the PIR sensor enters a "warm-up" period for about 15 seconds, then automatically switches into **AUTO MODE**.
2. During **AUTO MODE**, by switching the main switch **OFF-ON-OFF-ON** within 3 seconds as shown in Fig. 11, the PIR sensor will automatically change into **MANUAL MODE** from **AUTO MODE**. In **MANUAL MODE**, the lights will remain ON.

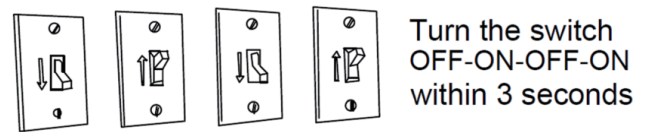

3. Turn the switch OFF - ON within 3 seconds, the manual mode will change to auto mode.

#### Step 4: Blue LED Sensor Indicator.

The Blue LED Light will flash to show that the PIR sensor is functioning properly.

### IMPORTANT NOTES

- Environmental temperature affects the sensor range. It is recommended not to mount the fixture near a heat source like an air conditioner, vent, or furnace exhaust, or in a direction facing a light reflecting object.
- The sensor will be more sensitive to motion across its detection path than motion coming directly towards it.
- For best performance, gently clean the lens with a soft cloth as needed to assure maximum sensitivity.

# INSTRUCTIONS

## LU160™ INSTALLATION



RAB Lighting is committed to creating high-quality, affordable, well-designed and energy-efficient LED lighting and controls that make it easy for electricians to install and end users to save energy. We'd love to hear your comments. Please call the Marketing Department at 888-RAB-1000 or email: [marketing@rablighting.com](mailto:marketing@rablighting.com)

### TROUBLESHOOTING

---

#### THE LIGHT WILL NOT COME ON

**Possible Cause:**

- The light switch is turned off.
- The fuse is blown or the circuit breaker is turned off.
- The light fixture is not properly attached to the mounting plate, if this is a new installation (*the pins are not fully seated in the terminal block*).
- The circuit wiring is incorrect, if this is a new installation.
- The detector is aimed in the wrong direction.
- The power voltage is wrong.

**Solution:**

- Turn the light wall switch on.
- Replace the fuse or turn the circuit breaker on.
- Re-install the light fixture to the mounting plate and ensure the pins are fully seated in the terminal block.
- Verify the wiring is correct.
- Re-aim the detector to cover the desired area.
- Verify that the power voltage is correct.

#### THE LIGHT COME ON DURING THE DAY

**Possible Cause:**

- The detector may be installed in a relatively dark location.
- The Ambient Light (LUX) level setting is wrong.
- The light fixture is on Manual Override Mode.

**Solution:**

- The light fixture is operating normally under these circumstances.
- Adjust the Ambient Light (LUX) level setting to the ☾ position.
- Adjust the light fixture to Auto Mode.

#### THE LIGHT STAYS ON CONTINUOUSLY

**Possible Cause:**

- Floodlight is positioned too close to the detector or pointed at nearby objects that cause heat to trigger the light detector.
- The light fixture is on Manual Override Mode.
- The light fixture is on the same circuit as a motor, transformer, or fluorescent bulb.

**Solution:**

- Reposition the Floodlight away from the detector or nearby objects.
- Adjust the light fixture to Auto Mode.
- Install the light fixture on a circuit without motors, transformers, or fluorescent bulbs. (*Dedicated Circuit*)

#### THE LIGHT COME ON FOR NO APPARENT REASON

**Possible Cause:**

- The motion sensor may be sensing small animals or automobile traffic.
- There is motion in the detection zone.
- The light fixture is wired through a dimmer or timer.

**Solution:**

- Decrease the "SENS" setting or reposition the motion sensor.
- Make sure the detector is not picking up moving objects such as trees, traffic, etc. and re-aim the detector.
- Do not use a dimmer or timer to control the light fixture. Replace the dimmer or timer with a standard on/off wall switch.

# INSTRUCTIONS

## LU160™ INSTALLATION



RAB Lighting is committed to creating high-quality, affordable, well-designed and energy-efficient LED lighting and controls that make it easy for electricians to install and end users to save energy. We'd love to hear your comments. Please call the Marketing Department at 888-RAB-1000 or email: [marketing@rablighting.com](mailto:marketing@rablighting.com)

### PARTS LIST

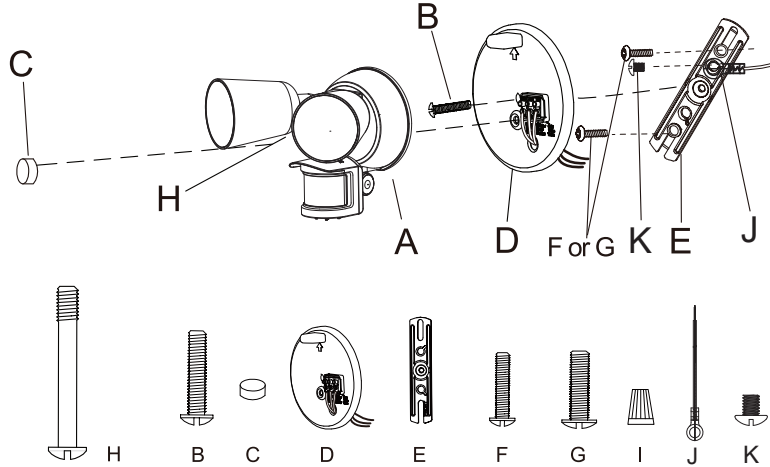

Part	Description	Quantity
A	Light Fixture	1
B	Small Mounting Bolt	1
C	Decorative Cover	1
D	Mounting Plate	1
E	Mounting Bracket	1
F	#6-32 x 1" Junction Box Screw	2
G	#8-32 x 1" Junction Box Screw	2
H	Large Mounting Bolt (pre-installed)	1
I	Wire Nut	3
J	Ground Wire	1
K	Ground Wire Screw	1

*Note: These instructions do not cover all details or variations in equipment nor do they provide for every possible situation during installation, operation or maintenance.*

#### Easy Answers