



Rugged die cast aluminum 6" diameter housings. Threaded, gasketed clear glass globe for durable weatherproofing and easy relamping. 1" long, 1/2" threaded nipple included for easy mounting. 75 Watt max.

Color: Black

Weight: 3.0 lbs

Project:	Type:
Prepared By:	Date:

Lamp Info		Ballast Info	
Type	A-19	Type	N/A
Watts	75W	120V	N/A
Shape/Size	N/A	208V	N/A
Base	N/A	240V	N/A
ANSI	N/A	277V	N/A
Hours	750	Input Watts	N/A
Lamp Lumens	1,220 lm		
Efficacy	N/A		

Technical Specifications

Compliance

UL Listed:

Suitable for wet locations. Suitable for mounting within 4 feet of the ground.

Electrical

Socket:

Medium base porcelain with all copper electrical parts and 20" leads, including a ground lead

Voltage:

120V AC

Construction

Globes:

Threaded, gasketed globe protects against weather, garden sprinklers and insects. Clear glass GL 100 globes standard for 4 Tier. Clear glass GL60 globes standard for 3 Tier. GL100 white globes also available for attractive appearance and glare reduction.

Housing:

Die-cast aluminum housing with powder coat finish

Mounting Stem:

Optional 12" mounting stem with 1/2" threads on both ends available [here](#).

Optical

Lamp:

Incandescent lamp not supplied. Medium base A-19 lamps, 120V. 75 watt max.

Other

Buy American Act Compliance:

RAB values USA manufacturing! Upon request, RAB may be able to manufacture this product to be compliant with the Buy American Act (BAA). Please contact customer service to request a quote for the product to be made BAA compliant.

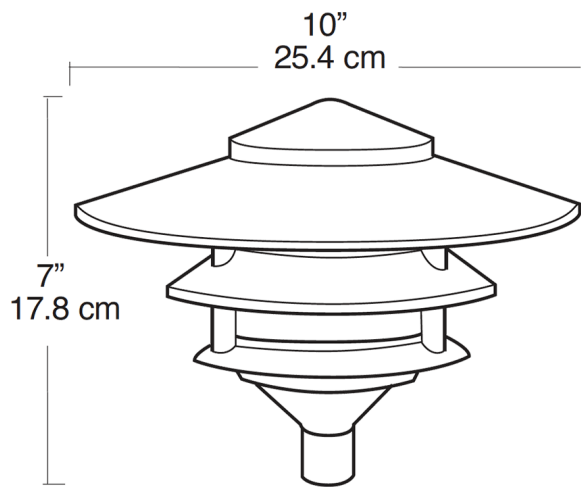
Dimensions**Features**

- Rugged die cast aluminum housing with durable powder coating
- Socket with all copper electrical parts and 20" leads
- Quick and secure installation with one corrosion-proof screw
- Threaded, gasketed globes for durable weatherproofing and easy relamping
- 12" color matched mounting stem with 1/2" threads available
- Includes easy mounting 1/2" threaded nipple