



Lightcloud<sup>®</sup>  
Controller Mini

LCCONTROL/MINI

WE'RE HERE TO HELP:

1 (844) LIGHTCLOUD

1 (844) 544-4825

[support@lightcloud.com](mailto:support@lightcloud.com)

# Hello

The Lightcloud Controller Mini  
is a remotely controlled switch  
and 0-10V dimming device.

## **Product Features**

Wireless Control & Configuration

Switching up to 4.2A

0-10V Dimming

Power Monitoring

*Patent Pending*

# Contents

Lightcloud Controller

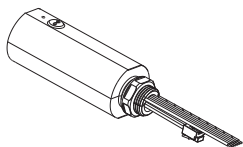

Lock Nut



O-ring



Wire Nuts



Instruction Manual

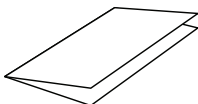

# Specifications

## PART NUMBER

LCCONTROL/MINI

## INPUT

120V-277VAC, 60Hz  
<0.8W (Standby and Active)

## MAXIMUM SWITCHED LOAD RATINGS

For Control of Electronic Ballast (LED)  
and Magnetic Ballast  
Electronic/Tungsten: 4.2A @120VAC  
Inductive/Resistive: 4.2A @120VAC, 1.8A @277VAC

## OPERATING TEMPERATURE

-35°C to +60°C

## OVERALL DIMENSIONS

1.6" diameter, 3.8" length  
1/2" NPT Mount, Male  
18AWG pigtails  
22AWG pigtails

## WIRELESS RANGE

Line-of-Sight: 1000 feet  
Obstructions: 100 feet

Class 2  
IP66 Rated  
Indoor and Outdoor Rated  
Wet and Damp Location  
Plenum Rated

# What You Need



## Lightcloud Gateway or Hub

A Lightcloud installation requires at least one Lightcloud Gateway or Hub to manage your devices.

WE'RE HERE TO HELP:

**1 (844) LIGHTCLOUD**

or 1 (844) 544-4825

[support@lightcloud.com](mailto:support@lightcloud.com)

# Wiring

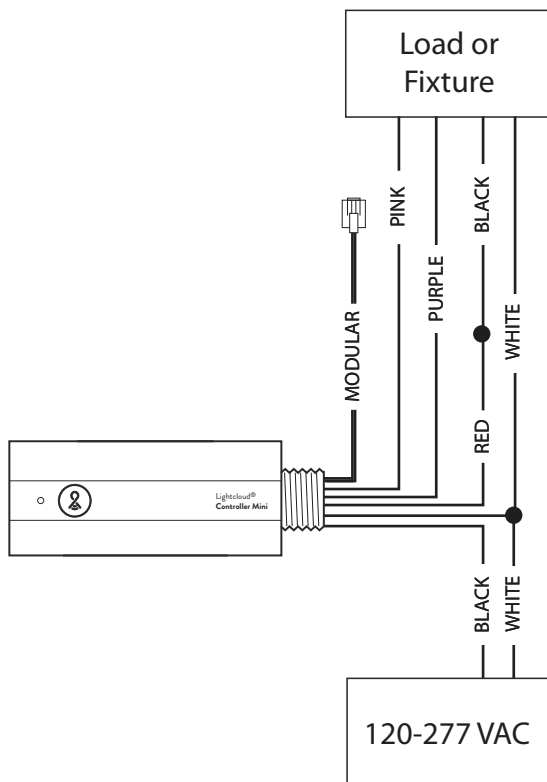

# Setup & Installation

## ① Turn Off Power

 **WARNING**

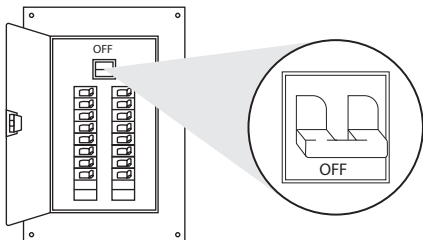

## 1a Find a Suitable Location

Use these guidelines when installing devices:

- If there is a clear line of sight between two Lightcloud devices, they can be placed up to 1000 feet apart.
- If the two devices are separated by ordinary drywall construction, try to keep them within 100 ft. of each other.
- Brick, concrete and steel construction may require additional Lightcloud devices to go around the obstruction.

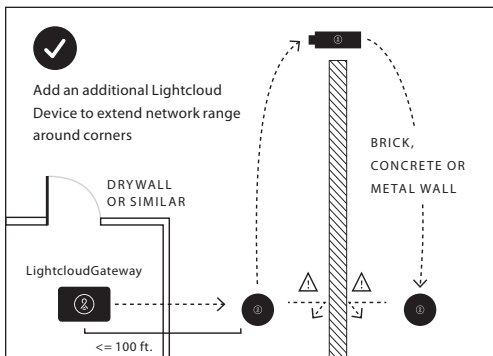

# Setup & Installation *(cont'd)*

## ② Install your Lightcloud Controller

### 2a Install at a Junction Box *(Indoor/Outdoor)*

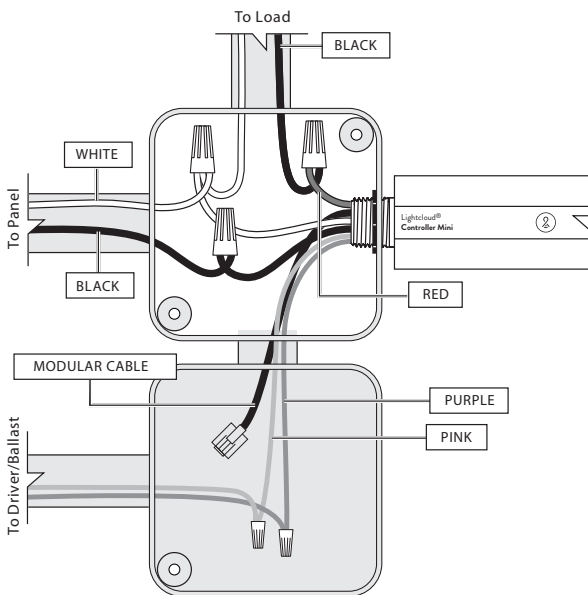

#### 0-10V DIMMING

0-10V is a common method of low-voltage control of dimmable drivers and ballasts. **Purple:** 0-10V positive | **Pink:** 0-10V common

**NOTE:** The National Electrical Code requires that low-voltage wiring used in the same enclosure as high-voltage wiring have an equal or better insulation rating. You may need to complete your low-voltage wiring in another enclosure or use a partition.

## 2b Install at Lighting Panel or Trough

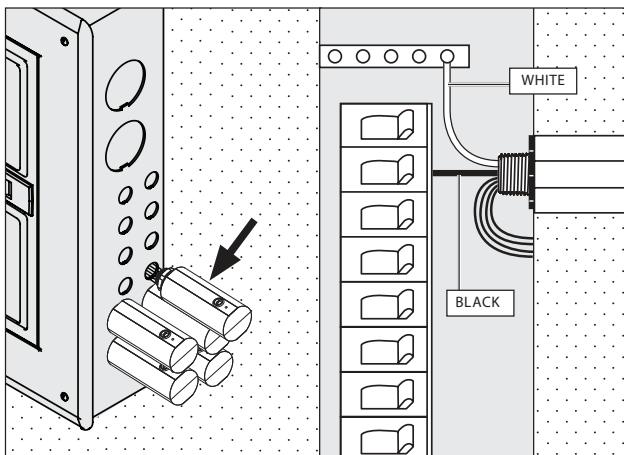

Space and code allowing, you may install Lightcloud devices directly in your breaker box or lighting panel. Alternatively, break out lighting circuits and install Lightcloud devices in a separate trough.

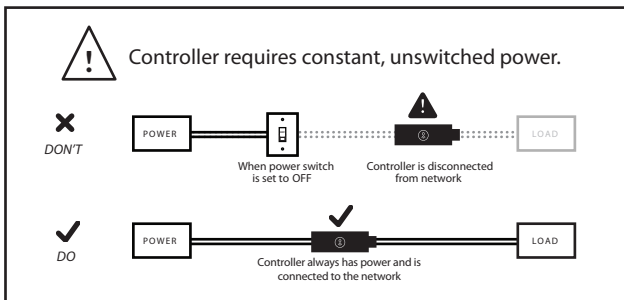



# Setup & Installation *(cont'd)*

## ③ Labeling Your device

When installing devices, it's important to keep track of their Device IDs, installation locations, panel/circuit #s, dimming function, and any additional notes. To organize this information, use the Lightcloud Installer Application (A) or Device Table (B).

### 3a Lightcloud Installer Application

**Install the LC Installer Application:** LC Installer is available for iOS and Android.

**Scan & Install Lightcloud Devices:** Scan each device and assign to a room. It's recommended that each device is scanned just before or just after being wired so no devices are missed. The more notes that are given, the easier it is to commission the system.

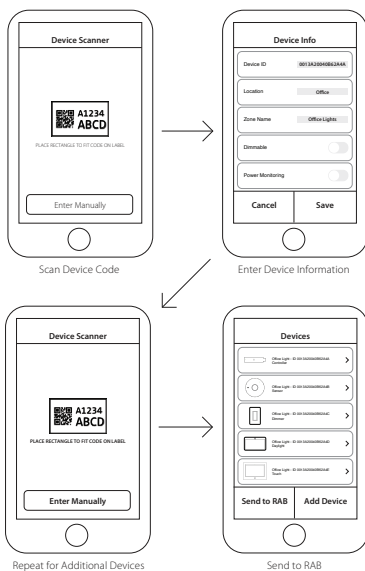

### 3b Device Table

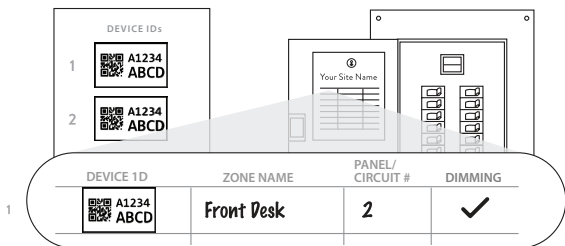

For setup and maintenance, we provide two Lightcloud Device Tables with the Gateway: one that you can attach to your panel and one to hand off to a building manager. Attach the Device Identification stickers included with each device to a row, then write in additional information, such as Zone name, Panel/Circuit Number, and whether or not a zone uses dimming.

**Send to RAB:** Once all of the devices have been added and organized, submit the information for commissioning.

### 4 Power up

To add new devices to your Lightcloud network, call RAB at 1 (844) LIGHTCLOUD, or email us at [support@lightcloud.com](mailto:support@lightcloud.com).

# Setup & Installation *(cont'd)*

## 5 Confirm Device Connectivity

Confirm Status Indicator is Solid Green *(see details below)*

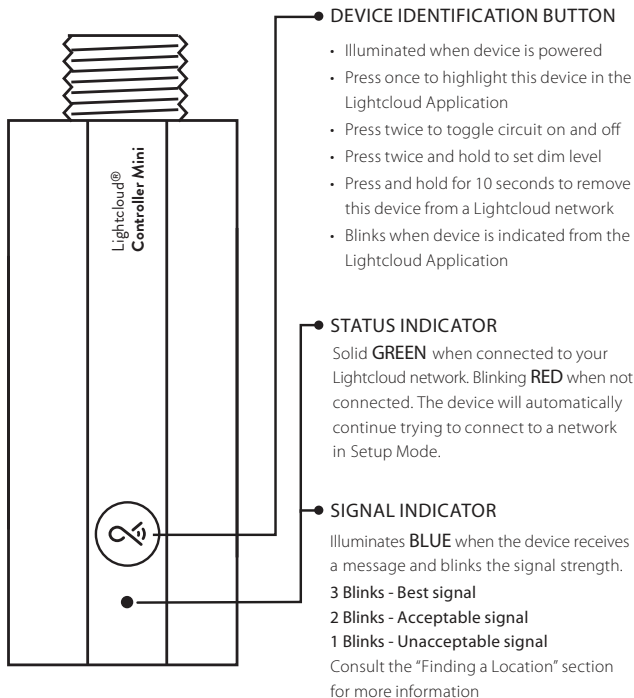

## 6 Commission your devices

Log on to [www.lightcloud.com](http://www.lightcloud.com) or call 1 (844) LIGHTCLOUD

# Functionality

## Configuration

To configure Lightcloud products, use the Web Application ([control.lightcloud.com](http://control.lightcloud.com)) or call 1(844)LIGHTCLOUD.

WE'RE HERE TO HELP:

**1 (844) LIGHTCLOUD**

or 1 (844) 544-4825

[support@lightcloud.com](mailto:support@lightcloud.com)

## Operating Modes

**CONTROLLER:** Provides switching and dimming for a single zone.

**REPEATER:** Extends the Lightcloud mesh network without controlling a load.

**SENSOR (REQUIRES OPTIONAL SENSOR MODULE):** Provides occupancy, vacancy, and daylight harvesting.

**POWER MEASUREMENT:** The Lightcloud Controller is capable of measuring the power usage of the attached circuit.

**POWER LOSS DETECTION:** If mains power to the Controller is lost, the device will detect this and alert the Lightcloud application.

**EMERGENCY DEFAULT:** If communication is lost, the Controller may optionally fall back to a specific state, such as turning the attached circuit on.



Controller requires constant, unswitched power. Any wires not in use must be capped off or otherwise insulated. This product should only be installed by a qualified electrician and in compliance with local and national electrical codes.

*FCC Information:*

*This device complies with Part 15 of the FCC Rules. Operation is subject to the following two conditions:*

- 1. This device may not cause harmful interference, and*
- 2. This device must accept any interference received, including interference that may cause undesired operation.*

*Note: This device has been tested and found to comply with the limits for Class A digital devices pursuant to Part 15A Subpart B, of the FCC rules. These limits are designed to provide reasonable protection against harmful interference in a residential environment. This equipment generates, uses, and can radiate radio frequency energy, and if not installed and used in accordance with the instruction manual, may cause harmful interference to radio communications. However, there is no guarantee that interference will not occur in a particular installation. If this equipment does cause harmful interference to radio or television reception, which can be determined by turning the equipment off and on, the user is encouraged to try and correct the interference by one or more of the following measures:*

- Reorient or relocate the receiving antenna.*
- Increase the separation between the equipment and receiver.*
- Connect the equipment into an outlet on a circuit different from that to which the receiver is connected.*
- Consult the dealer or an experienced radio/TV technician for help.*

*To comply with the FCC's RF exposure limits for general population / uncontrolled exposure, this transmitter must be installed to provide a separation distance of at least 20 cm from all persons and must not be co-located or operating in conjunction with any other antenna or transmitter.*

***CAUTION: Changes or modifications to this equipment not expressly approved by RAB Lighting may void the user's authority to operate this equipment.***



Lightcloud is a commercial wireless lighting control system. It's powerful and flexible, yet easy to use and install. **Learn more at [lightcloud.com](https://lightcloud.com)**

1 (844) LIGHTCLOUD

1 (844) 544-4825

[support@lightcloud.com](mailto:support@lightcloud.com)

**RAB<sup>®</sup>**

© 2022 RAB Lighting, Inc