

Welcome

Lightcloud®

24V Controller

LCBLV/TW

WE'RE HERE TO HELP:

1 (844) LIGHTCLOUD

1 (844) 544-4825

Hello

This 24VDC Lightcloud Blue tunable white Controller enables Bluetooth® Mesh wireless configuration and control through the Lightcloud Blue mobile app for on/off, dimming, color temperature adjustment, scenes, and scheduling.

Product Features

- 24VDC Power Input, 2-Channel Constant Voltage Output
- Bluetooth® Mesh Wireless Communication
- App-Based Configuration and Control
- On/Off, Dimming, Tunable White, Scenes, and Schedules
- No Gateway or Hub Required

Contents

Lightcloud Blue Controller

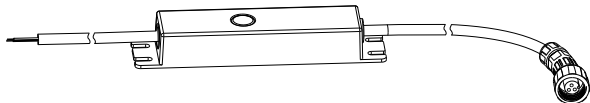

Mounting Screws
PWA0.118 +0.315"



X4

3M™ Adhesive Pad
Double-Sided, White, 0.984x1.181x0.02"



X2

Specifications & Ratings

PART NUMBER

LCBLV/TW

INPUT VOLTAGE

24Vdc

INPUT CURRENT

15.5A

OUTPUT POWER

2 x (48-96)W

DIMMING CURVE

Logarithmic

COMPATIBILITY

TNF/LCB, TOS/LCB, TIC/LCB

DIMENSIONS:

5.7" (L) x 1.22" (W) x 0.84" (H)

WIRELESS RANGE

Indoor: 60 ft thru obstructions,
up to 200 ft clear line of sight

Outdoor: 120 ft around corners,
up to 200 ft clear line of sight

RATINGS

IP66 Indoor/Outdoor

OPERATING TEMPERATURE

-22°F to 131°F (-30°C to 55°C)

Setup & Installation

① Turn off power

 WARNING

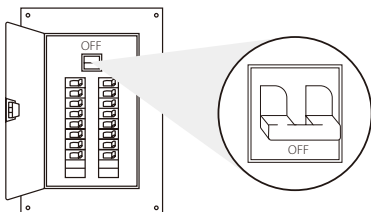

1a Find a suitable location

- Lightcloud Blue devices should be positioned within 60ft. of within wireless range
- Building materials such as brick, concrete and steel construction may require additional Lightcloud Blue devices to extend around an obstruction.
- All Lightcloud Blue devices require constant power for wireless communication.

INDOOR

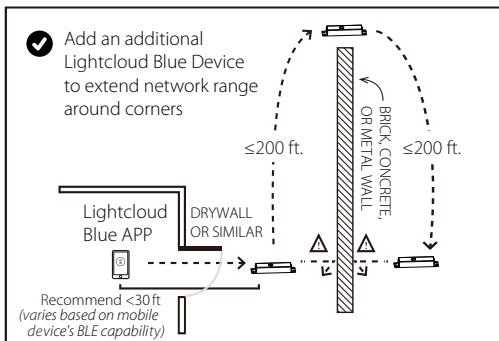

Setup & Installation (cont'd)

OUTDOOR

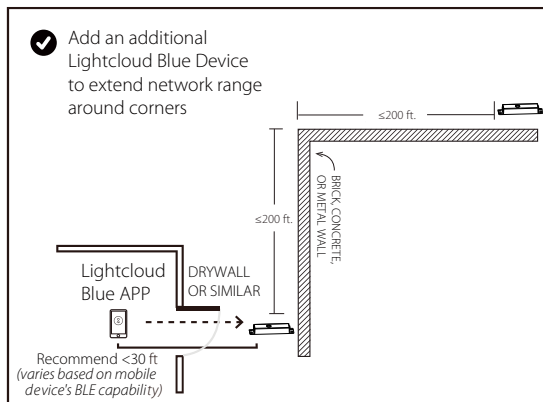

To enhance the mesh stability, add additional Controllers within range of each other.

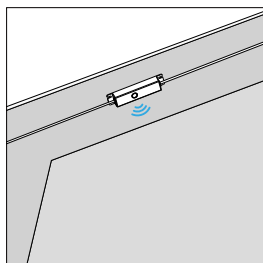
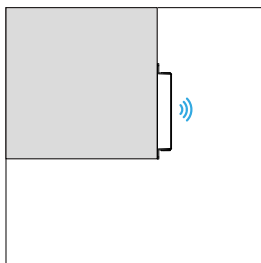

Setup & Installation *(cont'd)*

② Connect the Lightcloud Blue 24V Controller

2a Wire the driver to the controller

The 24V Controller bare leads will be connected to the driver's red wire to controller's black wire and driver's black wire to controller's white wire.

2b Connect the 3-pin Connector to Tape Light

Align the controller's 3-pin connector (female) to the tape light's 3-pin connector (male) and securely connect the two together with the twist lock.

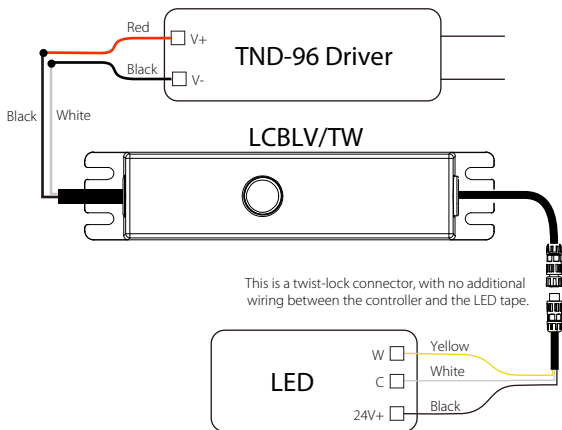

Setup & Installation *(cont'd)*

③ Mount the Controller

The 24V Controller can be surface mounted using the included mounting screws and 3M double sided adhesive tape.

④ Turn power on

All the Lightcloud Blue 24V Controller require a constant hot feed for wireless communication.

⑤ Verify power and local control

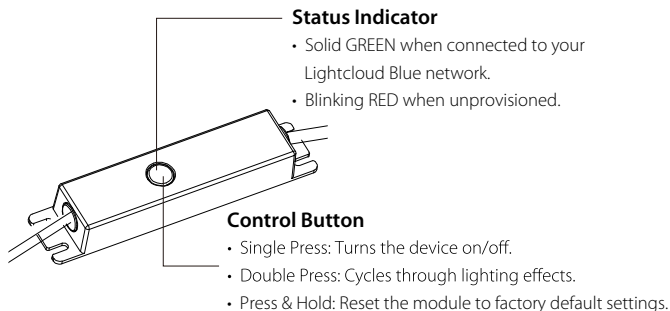

Confirm Status Indicator is blinking red. Confirm local control using the Control Button



Controlling your Lightcloud Blue Device

- ① Confirm your device is powered on and connected to constant power.
- ② Download the Lightcloud Blue app from the Apple® App Store or Google® Play store.



- ③ Launch the app and login or create an account.
- ④ Tap the "add device" icon in the app to start connecting devices.   
- ⑤ Select the Controller in the app and move to an Area to configure settings
- ⑥ You're all set!

Learn more →



Functionality

Configuration

All configuration of Lightcloud Blue products may be performed using the Lightcloud Blue mobile app.

Power Outage Recovery

If communication is lost, device will return to the last known ON status. Change via the mobile app

WE'RE HERE TO HELP:

1 (844) LIGHTCLOUD

1 (844) 544-4825

support@lightcloud.com

FCC Information:

This device complies with Part 15 of the FCC Rules. Operation is subject to the following two conditions: 1. This device may not cause harmful interference, and 2. This device must accept any interference received, including interference that may cause undesired operation.

Note: This device has been tested and found to comply with the limits for Class B digital devices pursuant to Part 15 Subpart B, of the FCC rules. These limits are designed to provide reasonable protection against harmful interference in a residential environment. This equipment generates, uses, and can radiate radio frequency energy, and if not installed and used in accordance with the instruction manual, may cause harmful interference to radio communications. However, there is no guarantee that interference will not occur in a particular installation. If this equipment does cause harmful interference to radio or television reception, which can be determined by turning the equipment off and on, the user is encouraged to try and correct the interference by one or more of the following measures:

- Reorient or relocate the receiving antenna.
- Increase the separation between the equipment and receiver.
- Connect the equipment into an outlet on a circuit different from that to which the receiver is connected.
- Consult the dealer or an experienced radio/TV technician for help.

To comply with the FCC's RF exposure limits for general population / uncontrolled exposure, this transmitter must be installed to provide a separation distance of at least 20 cm from all persons and must not be co-located or operating in conjunction with any other antenna or transmitter.

CAUTION: Changes or modifications to this equipment not expressly approved by RAB Lighting may void the user's authority to operate this equipment.

Lightcloud®

Lightcloud Blue is a Bluetooth® Mesh lighting control system designed for fast setup and flexibility. Install quickly with no gateways, hubs, or additional control wiring. Start with a single device and easily scale to control entire buildings.

Learn more at rablighting.com/lcb.

1(844) LIGHTCLOUD

1 (844) 544-4825

RAB®

©2026 RAB LIGHTING Inc.

Pat. rablighting.com/ip

P-102356