



Project:	Type:
Prepared By:	Date:

Driver Info		LED Info	
Type	Constant Current	Watts	45W
120V	0.39A	Color Temp	4000K (Neutral)
208V	0.22A	Color Accuracy	76 CRI
240V	0.19A	L70 Lifespan	100,000 Hours
277V	0.17A	Lumens	6,112 lm
Input Watts	46.9W	Efficacy	130.3 lm/W

Technical Specifications

Compliance

UL Listed:

Suitable for wet locations

IP Rating:

Ingress protection rating of IP66 for dust and water

IESNA LM-79 & lm-80 Testing:

RAB LED luminaires and LED components have been tested by an independent laboratory in accordance with IESNA lm-79 and lm-80

California Title 24:

Can be used to conform with the requirements of California Title 24 Part 6.

LED Characteristics

LEDs:

Long-life, high-efficacy, surface-mount LEDs

Color Stability:

LED color temperature is warrantied to shift no more than 200K in color temperature over a 5-year period

Color Uniformity:

RAB's range of Correlated Color Temperature follows the guidelines of the American National Standard for Specifications for the Chromaticity of Solid State Lighting (SSL) Products, ANSI C78.377-2017.

Performance

Lifespan:

Up to 100,000-Hour LED lifespan based on IES LM-80 results and TM-21 calculations

Construction

Cold Weather Starting:

The minimum starting temperature is -20°C (-4°F)

Maximum Ambient Temperature:

Suitable for use in up to 40°C (104°F)

Mounting:

Surface mount standard (accessories available for wall, pole and trunnion mount)

Lens:

Diffused Polymethyl Methacrylate (PMMA)

Finish:

Formulated for high durability and long-lasting color

Green Technology:

Mercury and UV free. RoHS-compliant components.

Sensor Specifications

Multi Level Motion Sensor:

/WS sensor options use state-of-the-art surface mount technology (SMT), just like cellular phones and beepers. SMT gives you more reliability, greater RF immunity. This compact sensor that can fit neatly where others cannot. This sensor technology automatically affects the state of operation for lighting systems or individual luminaires based upon detecting the presence or absence of movement for both people as they exit/enter, or for the motion of moving vehicles within the sensors viewing area. The wide 180° viewing angle can detect movement along the entire side of a building with only one compact sensor. The hard lens is molded as part of the case, vandalproof, rainproof, bugproof and absolutely sealed. Sensor functions best when movement is across its detection pattern, not towards the sensor.

Other

Warranty:

RAB warrants that our LED products will be free from defects in materials and workmanship for a period of five (5) years from the date of delivery to the end user, including coverage of light output, color stability, driver performance and fixture finish. RAB's warranty is subject to all terms and conditions found at rablighting.com/warranty.

Technical Specifications (continued)

Buy American Act Compliance:

RAB values USA manufacturing! Upon request, RAB may be able to manufacture this product to be compliant with the Buy American Act (BAA). Please contact customer service to request a quote for the product to be made BAA compliant.

Electrical

Driver:

Class 2, 50/60Hz, 120-277V, 4kV standard, 10kV optional, 120V: 0.38A, 208V: 0.22A, 240V: 0.19A, 277V: 0.17A

THD:

13.32% at 120V, 13.25% at 277V

Power Factor:

98.8% at 120V, 95.2% at 277V

Dimensions

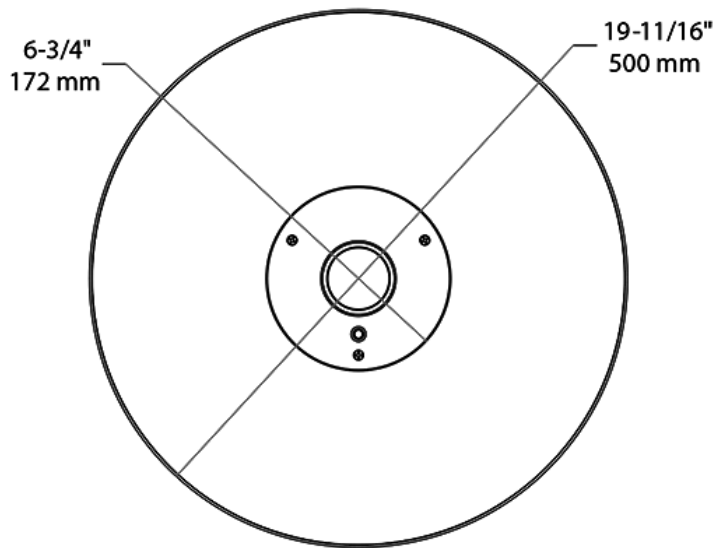

Ordering Matrix

Family	Distribution		Lumen Output	CRI/Color Temp	Finish	Voltage/Driver	Sensor Options	Lightcloud	Emergency Option
IVG	T5U	-	50L	740	W	U	/WS		
	T5 = Type V Wide T5C = Type V Concentrated T5U = Type V Wide with Uplight T5CU = Type V Concentrated with Uplight		30L = 3,600lm (28W) 50L = 5,500lm (45W) 70L = 7,500lm (69W)	750 = 70CRI 5000K 740 = 70CRI 4000K 730 = 70CRI 3000K	Z = Bronze ¹ W = White	U = 120-277V 0-10V Dimming 4 = 480V 0-10V Dimming ³	Blank = No Options /WS = 8ft lens Wattstopper /WS2 = 20ft lens Wattstopper	Blank = No Lightcloud® /LC = Lightcloud® Controller ²	Blank = No Options /E2 = Emergency ²

¹ Available only for T5 and T5C distribution

² Applies to 120-277V

³ Consult Factory