



Color: Bronze

Weight: 7.0 lbs

Project:

Type:

Prepared By:

Date:

Driver Info

Type	Constant Current
120V	0.24A
208V	0.14A
240V	0.12A
277V	0.11A
Input Watts	28.9W

LED Info

Watts	28W
Color Temp	4000K (Neutral)
Color Accuracy	76 CRI
L70 Lifespan	100,000 Hours
Lumens	4,037 lm
Efficacy	139.7 lm/W

Technical Specifications

Compliance

UL Listed:

Suitable for wet locations

IP Rating:

Ingress protection rating of IP66 for dust and water

Title 24 Compliant:

An IVEPARK edgelit garage fixture with a WS2 control option can be used to comply with 2016 Title 24 Part 6 Section 130.2 (a,b,c)

IESNA LM-79 & lm-80 Testing:

RAB LED luminaires and LED components have been tested by an independent laboratory in accordance with IESNA lm-79 and lm-80

LED Characteristics

LEDs:

Long-life, high-efficacy, surface-mount LEDs

Color Stability:

LED color temperature is warrantied to shift no more than 200K in color temperature over a 5-year period

Color Uniformity:

RAB's range of Correlated Color Temperature follows the guidelines of the American National Standard for Specifications for the Chromaticity of Solid State Lighting (SSL) Products, ANSI C78.377-2017.

Performance

Lifespan:

Up to 100,000-Hour LED lifespan based on IES LM-80 results and TM-21 calculations

Construction

Cold Weather Starting:

The minimum starting temperature is -20°C (-4°F)

Maximum Ambient Temperature:

Suitable for use in up to 40°C (104°F)

Mounting:

Surface mount standard (accessories available for wall, pole and trunion mount)

Lens:

Diffused Polymethyl Methacrylate (PMMA)

Finish:

Formulated for high durability and long-lasting color

Green Technology:

Mercury and UV free. RoHS-compliant components.

Other

Warranty:

RAB warrants that our LED products will be free from defects in materials and workmanship for a period of five (5) years from the date of delivery to the end user, including coverage of light output, color stability, driver performance and fixture finish. RAB's warranty is subject to all terms and conditions found at rablighting.com/warranty.

Buy American Act Compliance:

RAB values USA manufacturing! Upon request, RAB may be able to manufacture this product to be compliant with the Buy American Act (BAA). Please contact customer service to request a quote for the product to be made BAA compliant.

Electrical

Driver:

Class 2, 50/60Hz, 120-277V, 4kV standard, 10kV optional, 120V: 0.24A, 208V: 0.14A, 240V: 0.12A, 277V: 0.11A

THD:

10.51% at 120V, 14.89% at 277V

Power Factor:

98.8% at 120V, 91.3% at 277V

Dimensions

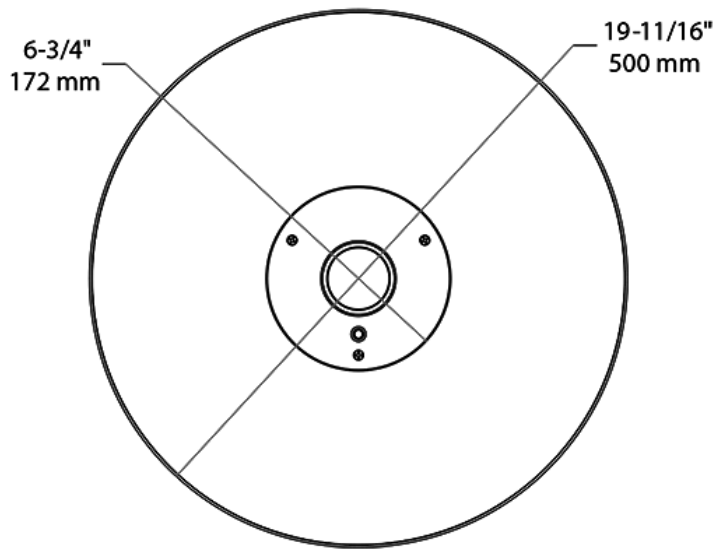
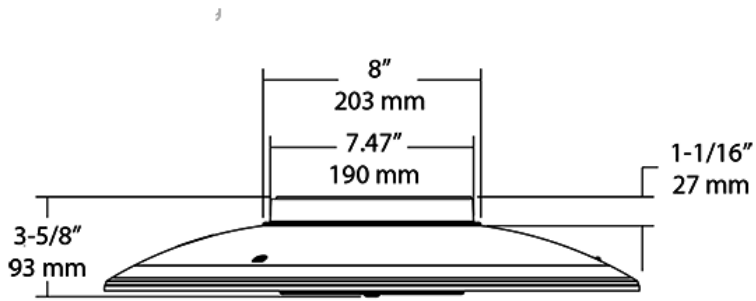

Ordering Matrix

Family	Distribution		Lumen Output	CRI/Color Temp	Finish	Voltage/Driver	Sensor Options	Lightcloud	Emergency Option
IVG	T5C	-	30L	740	Z	U			
	T5 = Type V Wide T5C = Type V Concentrated T5U = Type V Wide with Uplight T5CU = Type V Concentrated with Uplight		30L = 3,600lm (28W) 50L = 5,500lm (45W) 70L = 7,500lm (69W)	750 = 70CRI 5000K 740 = 70CRI 4000K 730 = 70CRI 3000K	Z = Bronze ¹ W = White	U = 120-277V 0-10V Dimming 4 = 480V 0-10V Dimming ³	Blank = No Options /WS = 8ft lens Wattstopper /WS2 = 20ft lens Wattstopper	Blank = No Lightcloud® /LC = Lightcloud® Controller ²	Blank = No Options /E2 = Emergency ²

¹ Available only for T5 and T5C distribution

² Applies to 120-277V

³ Consult Factory