

Dimensions

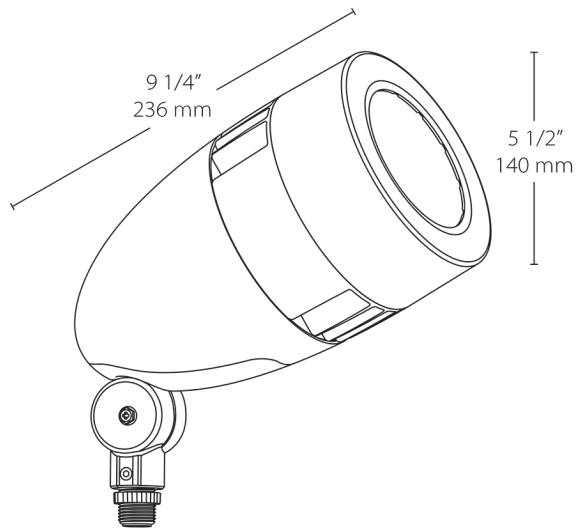

Features

- Spot lighting for over 40 feet away
- Perfect for flag lighting
- NEMA type - 4H x 4V
- Available in four colors
- 100,000-hour life based on LM-80 results and TM-21 calculations
- 5-Year, No-Compromise Warranty

Ordering Matrix

Family	Wattage	Color Temp	Finish	Driver Options
HSLED	26	N	W	/D10
26 = 26W	Blank = 5000K Cool	Blank = Bronze	Blank = No Option	
13 = 13W	N = 4000K Neutral	W = White	/D10 = 0-10V Dimming	
18 = 18W	Y = 3000K Warm	B = Black	/480 = 480V (Only available for 26W)	
		VG = Verde Green		
		A = Bronze		