



Hang straight swivels make mounting pendants to sloped ceilings easy.

Color: White

Weight: 0.2 lbs

Project:	Type:
Prepared By:	Date:

Technical Specifications

Performance

Description:

Hang straight 90° 1/2" NPS swivel mount sloped ceiling.

Construction

Maximum Weight:

HS90 suspends a light fixture with a maximum weight of 70 lbs

Application:

For indoor use only. Accessory is not rated for use in high-vibration environments.

Material:

Precision die cast aluminum

Finish:

Formulated for high durability and long-lasting color

Other

Buy American Act Compliance:

RAB values USA manufacturing! Upon request, RAB may be able to manufacture this product to be compliant with the Buy American Act (BAA). Please contact customer service to request a quote for the product to be made BAA compliant.

Electrical

THD:

11.6% at 120V, 21% at 277V

Dimensions

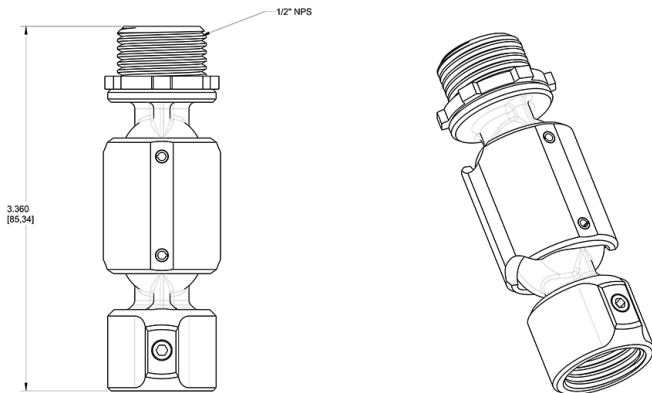

Features

Available in bronze and white and 45 or 90 degree angles

Fits 1/2" NPS