

Dimensions

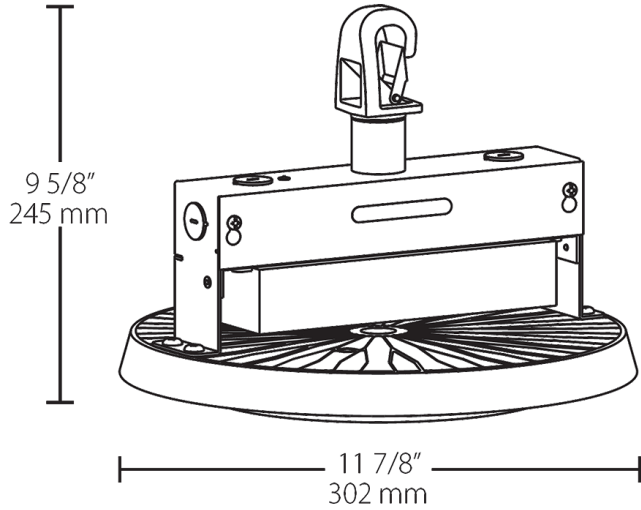

Features

- Simple. Affordable, Modular design.
- Open "airflow" design reduces operating temperatures and increases lifespan
- Assortment of reflectors tailor the Haybay to specific applications
- Available with a Lightcloud Controller, Lightcloud Sensor and other compatible RAB sensors

Ordering Matrix

Family	Wattage	Color Temp	Driver	Sensor Options	Options
HAYBAY	130		/D10	/LCSR	
	100 = 100W 130 = 130W 150 = 150W 180 = 180W	Blank = 5000K N = 4000K	/D10 = 0-10V Dimming (standard)	Blank = No Sensor /LOS = LOSBAY 800 Sensor (base fixture only) /LOS = LOSBAY 800 Sensor (required for reflector) /LC = Lightcloud® Controller /LCS = Lightcloud® Sensor (base fixture only) /LCSR = Lightcloud® Sensor (required for reflector)	Blank = No Battery Backup /E2 = Emergency Backup, 120-277V