

Technical Specifications (continued)

5 Yr Limited Warranty:

The RAB 5-year, limited warranty covers light output, driver performance and paint finish. RAB's warranty is subject to all terms and conditions found at rablighting.com/warranty.

Buy American Act Compliance:

RAB values USA manufacturing! Upon request, RAB may be able to manufacture this product to be compliant with the Buy American Act (BAA). Please contact customer service to request a quote for the product to be made BAA compliant.

Dimensions

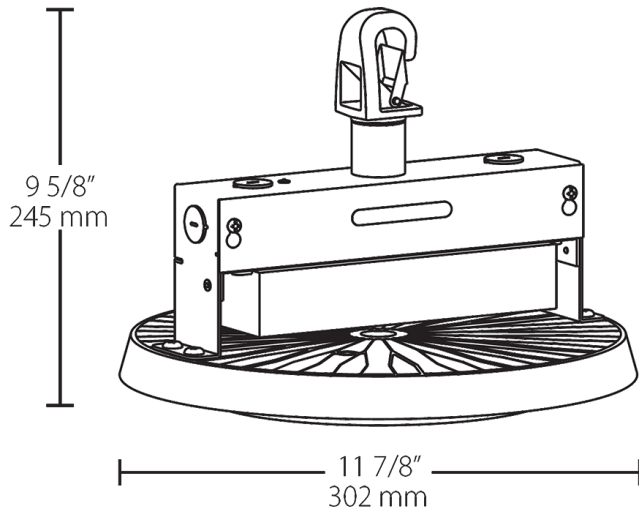

Features

- Simple. Affordable, Modular design.
- Open "airflow" design reduces operating temperatures and increases lifespan
- Assortment of reflectors tailor the Haybay to specific applications
- Available with a Lightcloud Controller, Lightcloud Sensor and other compatible RAB sensors

Ordering Matrix

Family	Wattage	Color Temp	Driver	Sensor Options	Options
HAYBAY	100		/D10	/LC	
	100 = 100W 130 = 130W 150 = 150W 180 = 180W	Blank = 5000K N = 4000K	/D10 = 0-10V Dimming (standard)	Blank = No Sensor /LOS = LOSBAY 800 Sensor (base fixture only) /LOSR = LOSBAY 800 Sensor (required for reflector) /LC = Lightcloud® Controller /LCS = Lightcloud® Sensor (base fixture only) /LCSR = Lightcloud® Sensor (required for reflector)	Blank = No Battery Backup /E2 = Emergency Backup, 120-277V