

## Satin Nickel Frame with Frosted Lens with Grill Style #3

*Note: Fixture will come fully assembled with the frame and lens shown above.*

<b>Project:</b>	<b>Type:</b>
<b>Prepared By:</b>	<b>Date:</b>

Driver Info		LED Info	
Type	Constant Current	Watts	25W
120V	0.22A	Color Temp	4000K (Neutral)
208V	0.13A	Color Accuracy	95 CRI
240V	0.11A	R9	82
277V	0.1A	L70 Lifespan	50,000 Hours
Input Watts	25.9W	Lumens	1,360 lm
		Efficacy	52.5 lm/W

## Technical Specifications

### Compliance

#### UL Listed:

Suitable for damp locations. Recommended for indoor use only.

#### ADA Compliant:

Meets ADA Requirements for wall-mounted luminaires.

#### Energy Star Approved:

ENERGY STAR® Version 2.0 Certified

#### IESNA LM-79 & lm-80 Testing:

RAB LED luminaires and LED components have been tested by an independent laboratory in accordance with IESNA lm-79 and lm-80

### Performance

#### Lifespan:

50,000-Hour LED lifespan based on IES LM-80 results and TM-21 calculations

#### Wattage Equivalency:

Equivalent to 100W Incandescent

### LED Characteristics

#### LEDs:

Long-life, high-efficacy, surface-mount LEDs; binned and mixed for uniform light output and color

#### Color Stability:

LED color temperature is warranted to shift no more than 200K in color temperature over a 5-year period

#### Color Uniformity:

RAB's range of Correlated Color Temperature follows the guidelines of the American National Standard for Specifications for the Chromaticity of Solid State Lighting (SSL) Products, ANSI C78.377-2017.

### Electrical

#### Driver:

Constant Current, Class 2, 120-277VAC, 50/60Hz, 350mA or 640mA

#### Dimming Driver:

0 - 10V (at 120-277V), TRIAC and ELV (at 120V only)

#### THD:

12.6% at 120V, 16.1% at 277V

#### Power Factor:

98.4% at 120V, 94.3% at 277V

#### Battery Backup Light Loss Factor:

0.18

### Construction

#### Housing:

Die-cast and extruded aluminum

#### Mounting:

Wall mount with junction box included

#### Lens:

Frosted polycarbonate with grill style #3. See [installation sheet](#) for cleaning instructions.

#### Operating Temperature:

-20°C (-4°F) to 40°C (104°F)

#### Green Technology:

Mercury and UV free. RoHS-compliant components.

#### Finish:

Luxuriously Electroplated Satin Nickel

## Technical Specifications (continued)

### Other

#### Warranty:

RAB warrants that our LED products will be free from defects in materials and workmanship for a period of five (5) years from the date of delivery to the end user, including coverage of light output, color stability, driver performance and fixture finish. RAB's warranty is subject to all terms and conditions found at [rablighting.com/warranty](http://rablighting.com/warranty).

#### Buy American Act Compliance:

RAB values USA manufacturing! Upon request, RAB may be able to manufacture this product to be compliant with the Buy American Act (BAA). Please contact customer service to request a quote for the product to be made BAA compliant.

## Dimensions

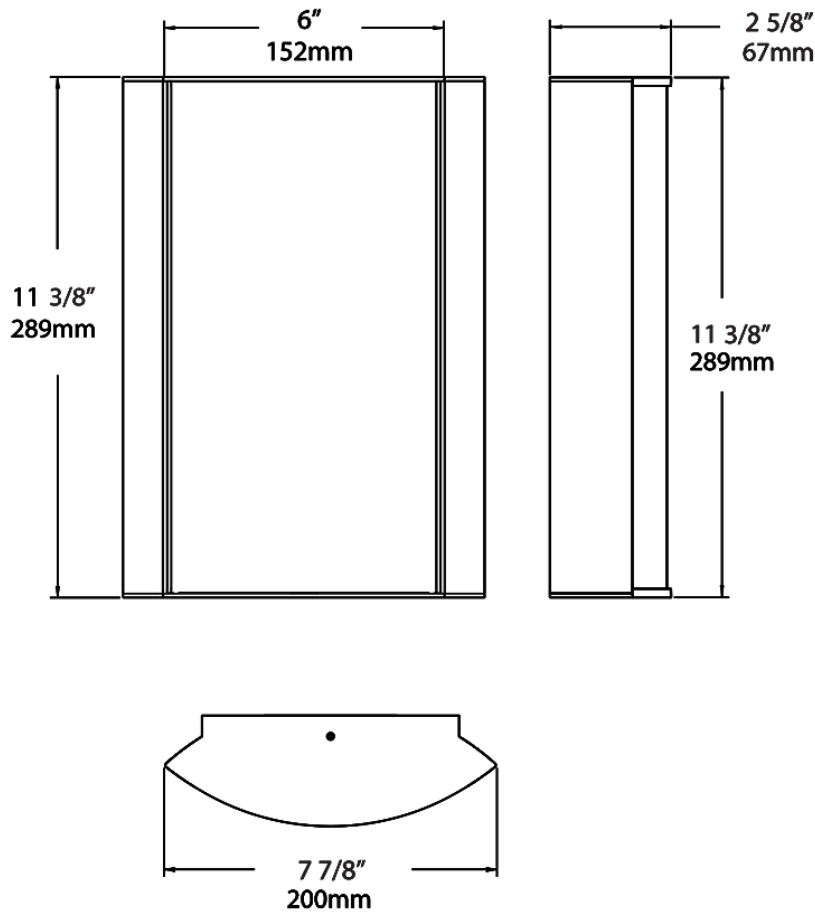

## Ordering Matrix

Family	Lumen Package	CRI/Color Temp		Lens		Finish	Options
HALV	18L	940	-	FG3	-	SA	

10L = 1000lm / 14W<sup>1</sup>  
 18L = 1800lm / 25W<sup>1</sup>

940 = 90CRI, 4000K  
 935 = 90CRI, 3500K  
 930 = 90CRI, 3000K  
 927 = 90CRI, 2700K

F = Frosted (Standard)  
 FG1 = Frosted with Grill Style #1  
 FG2 = Frosted with Grill Style #2  
 FG3 = Frosted with Grill Style #3  
 NL = Natural Leaves  
 GL = Green Leaves  
 TL = Toffee Leaves  
 LW = Linen Hampton White  
 LS = Linen Stone  
 LH = Linen Harbor  
 MS = Metallic Spun Silver  
 MC = Metallic Spun Copper  
 MG = Metallic Spun Gold  
 CW = Crush Polar White  
 CS = Crush Sedona  
 MP = Mirage Platinum  
 MA = Mirage Bronze

W = White  
 K = Black  
 S = Silver  
 A = Antique Bronze  
 SA = Satin Nickel  
 CU = Copper

Blank = No Option  
 /E2 = Battery Backup  
 /MVS = Microwave Occupancy Sensor<sup>2</sup>  
 /BL = Bi-Level Control  
 /LC = Lightcloud® Controller  
 /MVS/E2 = Microwave Occupancy Sensor w/ Battery Backup<sup>2</sup>  
 /BL/E2 = Bi-Level Control w/ Battery Backup  
 /LC/E2 = Lightcloud® Controller w/ Battery Backup

<sup>1</sup> Lumen values are approximations for models with a standard, frosted lens. Visit [rablighting.com](http://rablighting.com) for exact output based on your specific configuration.

<sup>2</sup> Available only with grill pattern