



Textured White Frame with Frosted Lens with Grill Style #3

Note: Fixture will come fully assembled with the frame and lens shown above.

Project:

Type:

Prepared By:

Date:

Driver Info

Type	Constant Current
120V	0.22A
208V	0.13A
240V	0.11A
277V	0.1A
Input Watts	25.9W

LED Info

Watts	25W
Color Temp	3000K (Warm)
Color Accuracy	94 CRI
R9	65
L70 Lifespan	50,000 Hours
Lumens	1,324 lm
Efficacy	51.1 lm/W

Technical Specifications

Compliance

UL Listed:

Suitable for damp locations. Recommended for indoor use only.

ADA Compliant:

Meets ADA Requirements for wall-mounted luminaires.

IESNA LM-79 & lm-80 Testing:

RAB LED luminaires and LED components have been tested by an independent laboratory in accordance with IESNA lm-79 and lm-80

Performance

Lifespan:

50,000-Hour LED lifespan based on IES LM-80 results and TM-21 calculations

Wattage Equivalency:

Equivalent to 100W Incandescent

LED Characteristics

LEDs:

Long-life, high-efficacy, surface-mount LEDs; binned and mixed for uniform light output and color

Color Stability:

LED color temperature is warrantied to shift no more than 200K in color temperature over a 5-year period

Color Uniformity:

RAB's range of Correlated Color Temperature follows the guidelines of the American National Standard for Specifications for the Chromaticity of Solid State Lighting (SSL) Products, ANSI C78.377-2017.

Electrical

Driver:

Constant Current, Class 2, 120-277VAC, 50/60Hz, 350mA or 640mA

Dimming Driver:

0 - 10V (at 120-277V), TRIAC and ELV (at 120V only)

THD:

12.6% at 120V, 16.1% at 277V

Power Factor:

98.4% at 120V, 94.3% at 277V

Battery Backup Light Loss Factor:

0.18

Construction

Housing:

Die-cast and extruded aluminum

Mounting:

Wall mount with junction box included

Lens:

Frosted polycarbonate with grill style #3. See [installation sheet](#) for cleaning instructions.

Operating Temperature:

-20°C (-4°F) to 40°C (104°F)

Green Technology:

Mercury and UV free. RoHS-compliant components.

Finish:

Textured White using our environmentally friendly polyester powder coatings are formulated for high-durability and long-lasting color

Other

Warranty:

RAB warrants that our LED products will be free from defects in materials and workmanship for a period of five (5) years from the date of delivery to the end user, including coverage of light output, color stability, driver performance and fixture finish. RAB's warranty is subject to all terms and conditions found at rablighting.com/warranty.

Technical Specifications (continued)

Buy American Act Compliance:

RAB values USA manufacturing! Upon request, RAB may be able to manufacture this product to be compliant with the Buy American Act (BAA). Please contact customer service to request a quote for the product to be made BAA compliant.

Dimensions

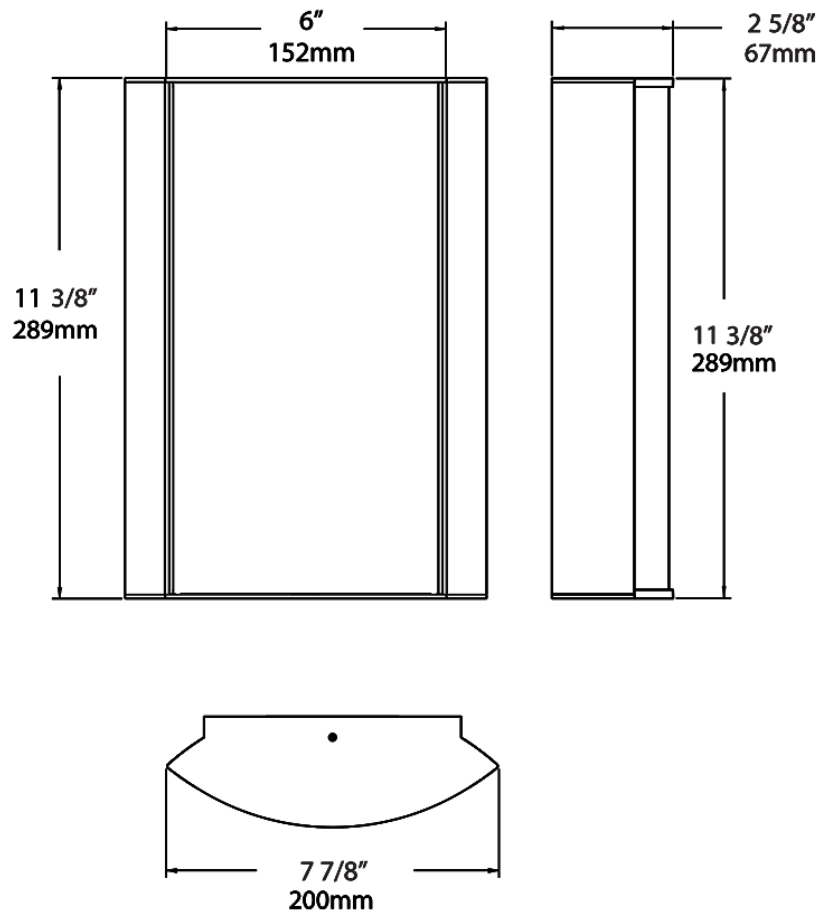

Ordering Matrix

Family	Lumen Package	CRI/Color Temp		Lens		Finish	Options
HALV	18L	930	-	FG3	-	W	

10L = 1000lm / 14W¹
 18L = 1800lm / 25W¹

940 = 90CRI, 4000K
 935 = 90CRI, 3500K
 930 = 90CRI, 3000K
 927 = 90CRI, 2700K

F = Frosted (Standard)
 FG1 = Frosted with Grill Style #1
 FG2 = Frosted with Grill Style #2
 FG3 = Frosted with Grill Style #3
 NL = Natural Leaves
 GL = Green Leaves
 TL = Toffee Leaves
 LW = Linen Hampton White
 LS = Linen Stone
 LH = Linen Harbor
 MS = Metallic Spun Silver
 MC = Metallic Spun Copper
 MG = Metallic Spun Gold
 CW = Crush Polar White
 CS = Crush Sedona
 MP = Mirage Platinum
 MA = Mirage Bronze

W = White
 K = Black
 S = Silver
 A = Antique Bronze
 SA = Satin Nickel
 CU = Copper

Blank = No Option
 /E2 = Battery Backup
 /MVS = Microwave Occupancy Sensor²
 /BL = Bi-Level Control
 /LC = Lightcloud® Controller
 /MVS/E2 = Microwave Occupancy Sensor w/ Battery Backup²
 /BL/E2 = Bi-Level Control w/ Battery Backup
 /LC/E2 = Lightcloud® Controller w/ Battery Backup

¹ Lumen values are approximations for models with a standard, frosted lens. Visit rablighting.com for exact output based on your specific configuration.

² Available only with grill pattern