

Project:	Type:
Prepared By:	Date:

Technical Specifications

Other

Threads:

1/2" NPS at the fixture Side

Buy American Act Compliance:

RAB values USA manufacturing! Upon request, RAB may be able to manufacture this product to be compliant with the Buy American Act (BAA). Please contact customer service to request a quote for the product to be made BAA compliant.

Construction

Diameter:

Diameter of the tube is 1"

Mounting:

The wall plate does not mount to a junction box but directly to the mounting surface with the proper hardware for the surface

Component Only:

This is a component for ordering LED Goosenecks. Not a complete fixture without Shade and Head.

Construction:

Die cast aluminum

Finish:

Formulated for high durability and long-lasting color

Dimensions

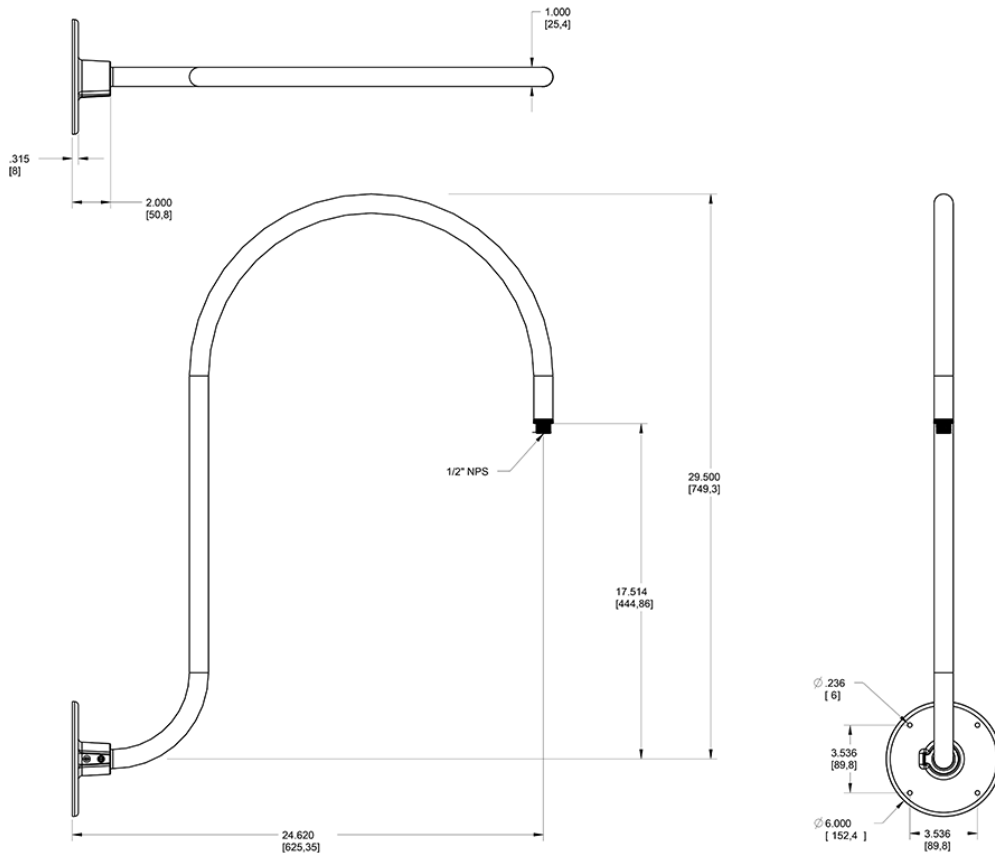

Ordering Matrix

Family	Style	Finish
GOOSE	3	W

- 1 = Arm Style 1
- 2 = Arm Style 2
- 3 = Arm Style 3
- 4 = Arm Style 4
- 5 = Arm Style 5
- B = Black
- W = White
- A = Bronze
- S = Silver
- G = Hunter Green
- YL = Yellow
- LB = Light Blue
- BL = Royal Blue
- BWN = Brown
- I = Ivory
- R = Red