



Flat or round bottom wire clamp guard made of No. 8 gauge steel rod welded to a clamping band. Guard is protected from corrosion by a baked silver gray polyester powder finish.

Color: Silver gray

Weight: 0.4 lbs

Project:

Type:

Prepared By:

Date:

Technical Specifications

Compliance

UL Listed:

Suitable for wet locations when used with RAB Vapor proof fixtures

Construction

Die Cast Guards:

One pieced die cast aluminum. Set screw locks guard in place. Also a wire clamp guard is available.

Wire Clamp Guards:

No. 8 gauge steel wire rod welded to clamping band with captive clamping screw.

Other

Buy American Act Compliance:

RAB values USA manufacturing! Upon request, RAB may be able to manufacture this product to be compliant with the Buy American Act (BAA). Please contact customer service to request a quote for the product to be made BAA compliant.

Dimensions

100w: 4" (10.2cm)
200w: 5 3/8" (13.7cm)

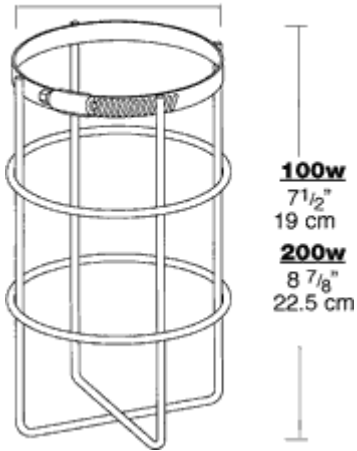

Features

- Set screw locks guard in place
- Machined threads for smooth running fit on Vaporproof fixtures
- Heavy, one-piece aluminum die casting
- Captive clamping screw won't fall out
- Threaded aluminum ring secures reflector to fixture