

Project:	Type:
Prepared By:	Date:

Driver Info		LED Info	
Type	Constant Current	Watts	150W
120V	1.39A	Color Temp	3000K (Warm)
208V	0.80A	Color Accuracy	71 CRI
240V	0.70A	L70 Lifespan	100,000 Hours
277V	0.60A	Lumens	20,734 lm
Input Watts	167.1W	Efficacy	124.1 lm/W

Technical Specifications

Compliance

UL Listed:

Suitable for wet locations. Suitable for mounting within 4ft (1.2m) of the ground.

IESNA LM-79 & lm-80 Testing:

RAB LED luminaires and LED components have been tested by an independent laboratory in accordance with IESNA lm-79 and lm-80

IP Rating:

Ingress protection rating of IP66 for dust and water

Performance

Lifespan:

100,000-Hour LED lifespan based on IES LM-80 results and TM-21 calculations

Wattage Equivalency:

Equivalent to 400W Metal Halide

Other

Note:

All values are typical (tolerance +/- 10%)

Warranty:

RAB warrants that our LED products will be free from defects in materials and workmanship for a period of five (5) years from the date of delivery to the end user, including coverage of light output, color stability, driver performance and fixture finish. RAB's warranty is subject to all terms and conditions found at rablighting.com/warranty.

Buy American Act Compliance:

RAB values USA manufacturing! Upon request, RAB may be able to manufacture this product to be compliant with the Buy American Act (BAA). Please contact customer service to request a quote for the product to be made BAA compliant.

LED Characteristics

LEDs:

Long-life, high-efficacy, surface-mount LEDs

Color Stability:

LED color temperature is warrantied to shift no more than 200K in color temperature over a 5-year period

Color Uniformity:

RAB's range of Correlated Color Temperature follows the guidelines of the American National Standard for Specifications for the Chromaticity of Solid State Lighting (SSL) Products, ANSI C78.377-2017.

Construction

EPA:

2

Ambient Temperature:

Suitable for use in up to -40°C (-40°F) to 40°C (104°F)

Lens:

Tempered glass lens included

Housing:

Die-cast aluminum housing and door frame

Mounting:

Heavy-duty Trunnion mount with stainless steel hardware

Finish:

Formulated for high durability and long-lasting color

Electrical

Driver:

Constant Current, Class 2, 120-277V, 50/60 Hz, 120V: 1.39A, 208V: 0.81A, 240V: 0.70A, 277V: 0.60A

THD:

1.42% at 120V, 7.59% at 277V

Technical Specifications (continued)

Power Factor:

99.9% at 120V, 97.6% at 277V

Photocell:

120-277V Twistlock photocell included. Photocell is compatible with 120-277V.

Dimensions

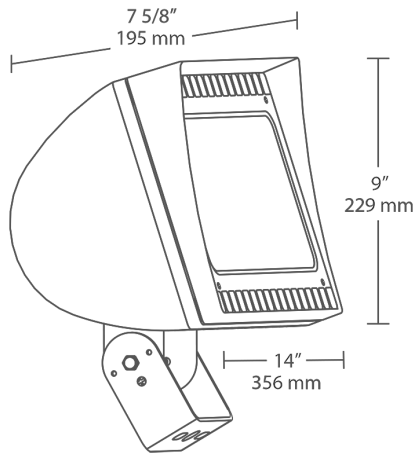

Features

- 66% energy cost savings vs. HID
- NEMA Type - 6H x 6V
- "Air-Flow" technology heat dissipation
- 100,000-hour LED lifespan
- 5-Year, No-Compromise Warranty

Ordering Matrix

Family	Wattage	Mounting	Color Temp	Finish	Driver	Options	Other Option
FXLED	150	T	Y	W		/PCT	
	78 = 78W 105 = 105W 125 = 125W 150 = 150W	SF = Slipfitter T = Trunnion	Blank = 5000K Cool N = 4000K Neutral Y = 3000K Warm	Blank = Bronze W = White	Blank = Standard /D10 = 0-10V Dimming /BL = Bi-Level /480 = 480V	Blank = No Option /LC = Lightcloud® Controller /PCT = 100-277V Twistlock /PCT4 = 480V Twistlock	Blank = Standard USA = BAA Compliant