



Rectangular shaped LED floodlight designed to replace 175W Metal Halide. patent-pending "Air-Flow" technology ensures long LED and driver lifespan. Use for building façades lighting, sign lighting, LED landscape lighting and instant-on security lighting.

Color: White

Weight: 12.5 lbs

Project:	Type:
Prepared By:	Date:

Driver Info		LED Info	
Type	Constant Current	Watts	52W
120V	N/A	Color Temp	3000K (Warm)
208V	N/A	Color Accuracy	71 CRI
240V	N/A	L70 Lifespan	100,000 Hours
277V	N/A	Lumens	6,344 lm
Input Watts	56.8W	Efficacy	111.7 lm/W

Technical Specifications

Compliance

UL Listed:

Suitable for wet locations. Suitable for mounting within 4ft (1.2m) of the ground.

Electrical

Driver:

Constant Current, Class 2, 100-277V, 50/60 Hz, 4 kV surge protection, 480V: 0.13A, 347V: 0.11A

Dimming Driver:

Driver includes dimming control wiring for 0-10V dimming systems. Requires separate 0-10V DC dimming circuit. Dims down to 10%.

THD:

4.18% at 480V

Power Factor:

93.5% at 480V

Performance

Lifespan:

100,000-Hour LED lifespan based on IES LM-80 results and TM-21 calculations

Wattage Equivalency:

Equivalent to 200W Metal Halide

Other

Note:

All values are typical (tolerance +/- 10%)

Warranty:

RAB warrants that our LED products will be free from defects in materials and workmanship for a period of five (5) years from the date of delivery to the end user, including coverage of light output, color stability, driver performance and fixture finish. RAB's warranty is subject to all terms and conditions found at rablighting.com/warranty.

Patents:

The FFLED design is protected by U.S. Pat. D643,147, Canada Pat. 140798, China Pat. ZL201130171304.1, Mexico Pat. 36757 and pending patent in Taiwan.

Buy American Act Compliance:

RAB values USA manufacturing! Upon request, RAB may be able to manufacture this product to be compliant with the Buy American Act (BAA). Please contact customer service to request a quote for the product to be made BAA compliant.

Construction

Ambient Temperature:

Suitable for use in up to 40°C (104°F)

Cold Weather Starting:

The minimum starting temperature is -40°C (-40°F)

Thermal Management Housing:

Superior heat sinking with external Air-Flow fins

Housing:

Die-cast aluminum housing, lens frame and mounting arm

Threaded Size:

1/2" threaded arm

Mounting:

Heavy-duty mounting arm with "O" ring seal & stainless steel screw

Effective Projected Area:

EPA = 0.65

Reflector:

Specular polycarbonate

Gaskets:

High-temperature silicone gaskets

Finish:

Formulated for high durability and long-lasting color

Technical Specifications (continued)

Green Technology:

Mercury and UV free. RoHS-compliant components.

LED Characteristics

Color Consistency:

3-step MacAdam Ellipse binning to achieve consistent fixture-to-fixture color

Color Stability:

LED color temperature is warranted to shift no more than 200K in color temperature over a 5-year period

Color Uniformity:

RAB's range of Correlated Color Temperature follows the guidelines of the American National Standard for (SSL) Products, ANSI C78.377-2017.

Optical

NEMA Type:

NEMA Beam Spread of 5H x 5V

Dimensions

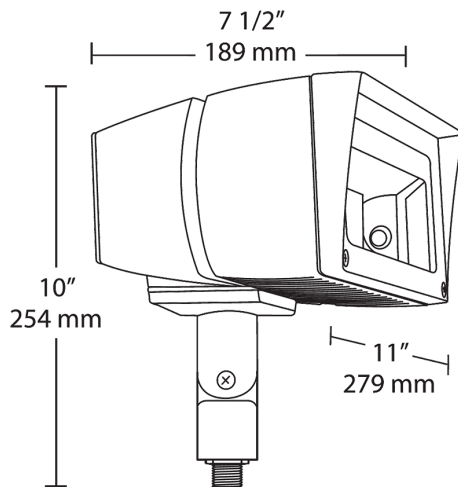

Features

Ultra-efficient LED and optical design

Replaces 175W MH floodlights

100,000-hour life based on LM-80 results and TM-21 calculations

"Air-Flow" technology heatsink

5-Year, No-Compromise Warranty

Ordering Matrix

Family	Wattage	Mounting	Color Temp	NEMA Type	Finish	Driver	Options	Other Options
FFLED	52		Y	B55	W	/480		
	26 = 26W 39 = 39W 52 = 52W 80 = 80W 18 = 18W	Blank = Swivel Arm SF = Slipfitter T = Trunnion	Blank = 5000K Cool N = 4000K Neutral Y = 3000K Warm	Blank = 7H x 6V B55 = 5H x 5V B44 = 4H x 4V	Blank = Bronze W = White	Blank = On/Off ¹ /D10 = 0-10V Dimming /480 = 480V On/Off ²	Blank = No Option /PCU = 120V Button Photocell /PC = 120V Photocell /PC2 = 277V Photocell /PCS = 120V Swivel Photocell /PCS2 = 277V Swivel Photocell /PCS4 = 480V Swivel Photocell	Blank = Standard USA = BAA Compliant

¹ Dimming Driver for 18W, 26W & 39W models only

² Not available for 80W models